

# free flight • vol libre

4/94  
Aug/Sep

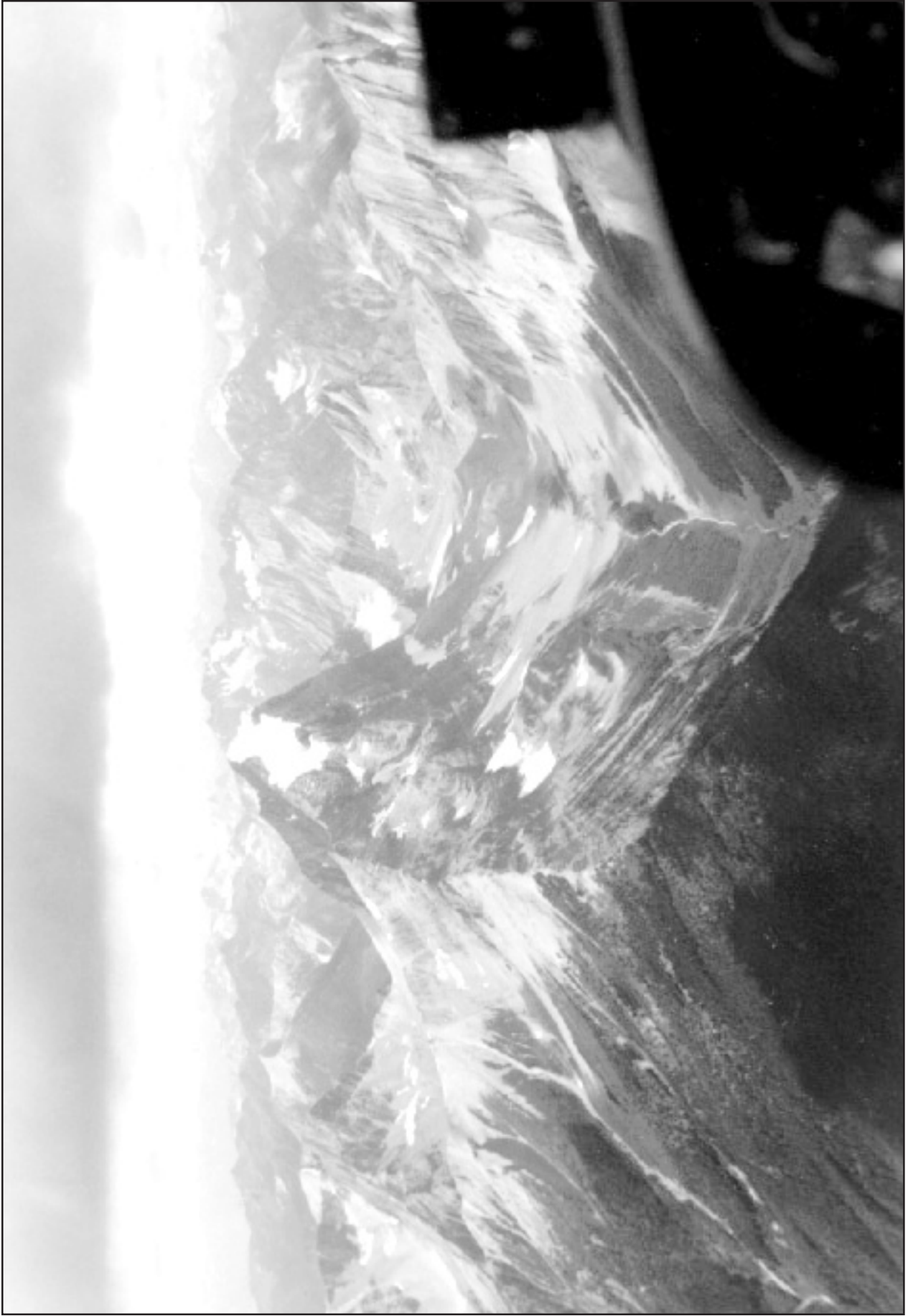

# Liaison



Our safety network is taking form quite nicely. Ken Brewin has recruited nine safety liaison officers who will be interacting with the individual clubs. I feel strongly that we have taken a giant step in the right direction. Now the work is only starting and each club will have to get involved and sensitize every member to this essential issue. If we ever want to be more self regulated at some point in the future, we have to show that we have a good track record in the areas we currently control.

A short phrase in George Eckschmiedt's annual report upset the people involved in the Air Cadet gliding training. I am positive that this was not the intent. Fortunately this event has made possible a renewed level of communication between the two organizations. Bob Mercer, our liaison person with the Air Cadet League of Canada, has written a letter that I encourage everyone to read. It is important that we understand under what parameters the Air Cadet flying training program operates. You will hear more about that topic in the months to come. They train over 500 pilots every year and it is a sin that we cannot recruit more of these young people. With all due respect to the EAA Young Eagles program, I believe that focusing on these trained Air Cadet pilots will bring more immediate returns. Bob will work on a proposal for a cadet "package" to attract more of these fine young people. This should be ready by our next AGM.

The last topic I will address stems from a conversation I had with Gordon Waugh and Charles Yeates in Halifax a few weeks ago. Charles was sharing his Australian experience and mentioned that someone down under had imported some low time (under 1000 hours) L-13 Blaniks from eastern Europe for some incredibly low price (way under US\$10,000). I'm interested in knowing if you people out there think I am smoking rope or if there is some point in SAC pursuing the matter further. The scenario could look like this: we get commitments from clubs and individual members for let's say a dozen ships. We send over a team of three individuals: an AME, a Transport Canada person that will help us select those units that they will approve to licence and someone with sharp negotiation skills (and why not some importing experience). I would love to hear from anyone but also from clubs. I will leave it at that for the time being — Tony tells me I was too wordy last time.

Happy thermals.

Au moment de lire ces lignes, la session de formation en français pour instructeurs aura eu lieu à Québec. Au moment d'écrire ces lignes, les six des neuf candidats inscrits proviennent du club local. Bravo! J'ose espérer qu'encore plus de membres des autres clubs se seront ajoutés à ce groupe. Pour rendre plus accessible cet important programme, nous essayons une formule différente. Au lieu de faire la formation durant 5 jours sur semaine, la formation aura lieu durant deux fins de semaine. J'ai tout lieu de croire que cette formule attirera plus d'adeptes dans les années à venir que la façon traditionnelle.

Sur une note plus triste, il appert que Sportair a mis un terme à ses activités en tant que club de vol à voile. La piste de St. Charles de Mandeville a un X et est donc effectivement fermée. J'ignore les circonstances qui ont mené à cet état de choses et je ne veux pas créer une polémique, du moins pas à ce sujet. On ne m'en voudra pas de regretter la chose. On est si peu nombreux à pratiquer ce sport au Québec!

Bonnes thermiques et s'il vous plaît soyez prudents.

**Pierre Pepin** president

# free flight • vol libre

Trademark pending    Marque de commerce en instance

4/94 Aug/Sep

The journal of the Soaring Association of Canada  
Le journal de l'Association Canadienne de Vol à Voile

---

ISSN 0827 - 2557

- 4 **Changes**  
editorial — Tony Burton
- 6 **Fronts**  
a summary of frontal characteristics — Tom Bradbury
- 9 **BC safari diary**  
some great cross-mountain flights — Mike Thompson
- 10 **1994 Nationals**  
hot, humid, hazy, and one great day — Stephen Liard
- 14 **Test driving '54'**  
the first flight in my own ship into a crop — Gerald Ince
- 16 **The side effects of Aspartame in diet drinks**  
the risks and low probability reactions — Dr Peter Perry
- 18 **Vital action checks**  
suggestions for making them more foolproof — Ian Oldaker
- 20 **The 7 S's**  
a landout checklist that helicopter pilots use — George Szukala

## DEPARTMENTS

- 5 **Letters & Opinions** — Air Cadet flight training, Bronze badge red tape, searching for Diamants, acceptable control locks.
- 21 **Incident reports** — pilot report on an in-flight rudder cable failure.
- 22 **Club News** — MSC '94 soaring?, the world record excuse, lake effect, "the Book of the Best" - what happened to the club copy?
- 24 **SAC Affairs** — The office is moving, club membership stats, coming events, mike preamp circuit, trophy flight data needed, "Horizon" - a fine poem, Ontario Soaring Society notes.
- 26 **FAI page** — FAI badges and records, Sporting Code amendment, a new way to declare distance records studied.

---

Cover "Mountain flying, 9 May 94, just north of Golden, BC"

photo: Fred Wollrad

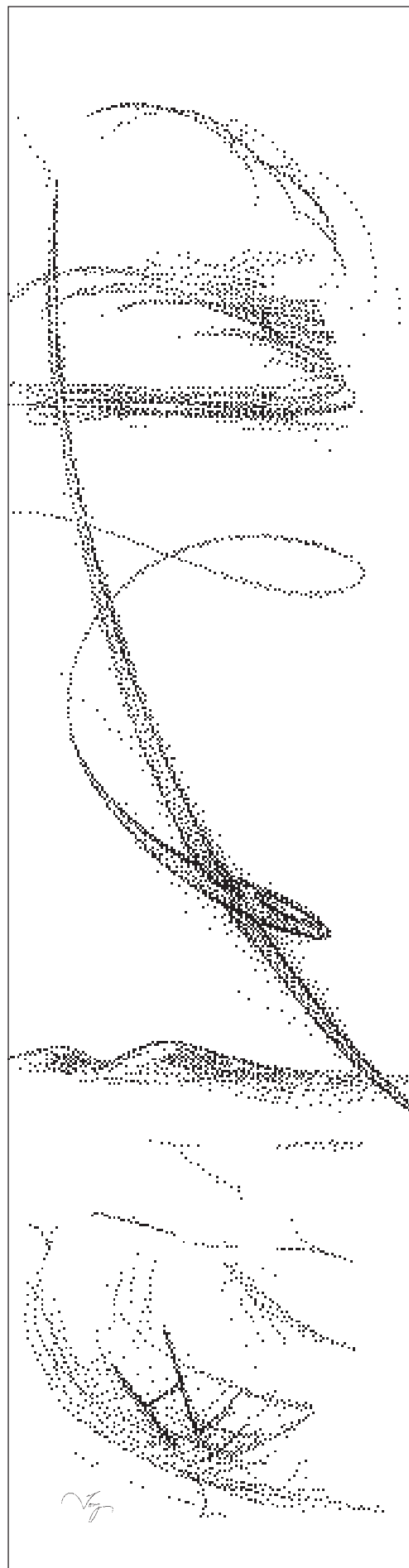

# Changes

You will notice a new look to *free flight* here inside in the style of the body text of the magazine. For all you typeface fanatics out there with DTP software, I moved from the fairly plain Jane "Helvetica" family of fonts to the "Optima" typeface. Both are sans serif, but where the former Helvetica Light had constant width in the letter strokes, Optima has variations in line width which I hope you will find more readable and stylish. The body text is slightly larger too, which should also aid readability.

With the 50th anniversary of SAC close upon us next year, I intend to put out a special *free flight*, probably the 1/95 Feb/Mar issue. It will have colour photos and many extra pages, but what goes into it is still open. Of course there will be a historical tilt, with emphasis on the characters that made SAC, and on the flights and sailplanes which distinguish our special branch of aviation with its elegance of form and perfection of function.

However, this special issue isn't going to appear out of the void without material support from you. Photos of historical significance in Canadian soaring will be very useful if you can also provide caption text on the photo content. If you still have good colour gliding photos in your album, I would like to see them, if you haven't — go out and take some. And although I will be borrowing interesting articles from past issues of *free flight*, these will only complement stories I get from you. Old stories are fresh to most new pilots in this rapidly changing sport, but I do hope that you who have been long in the sport will give a thought to the importance the sport has had to you over the years and tell us about it. So please consider yourself on notice right now to help make the 50th anniversary issue as good as it can be. My deadline is right after you have quickly dotted the last 'i' or fished through your photos. Thanks.

On a personal rest note, all you guys in Ontario and other eastern parts please remember that my fax and phone is the same number, so don't wake me up at 7am to fax the great news of your upcoming glider sale!

With SAC's increased emphasis on safety and training, *free flight* is also trying to publish really useful flight safety material. Simply haranguing pilots constantly to write accident and incident reports doesn't seem to be improving the response much, perhaps because these reports get back to us only once a year by way of dry statistics. In this issue, we have begun a department called "incident reports" in which an extended analysis of a specific event will be published. Dave Burgess' account of his rudder cable failure in this issue is gripping. With your future input, this can be a very interesting and valuable feature because of its greater currency and "first person" interest. Gerald Ince has also written a great article about his first flight in his new glass ship, and then what happened! It's a good story especially for his analysis of the event as much as the flight itself, because it's *really useful* that-could-easily-happen-to-me stuff for other new pilots who will be taking the same road soon.

**Tony Burton**, editor

Effective **1 September**, the new address and telephone for SAC will be:

**Suite 111 – 1090 Ambleside Dr  
Ottawa, ON K2B 8G7  
(613) 829-0536, fax 829-9497**



## The SOARING ASSOCIATION OF CANADA

is a non-profit organization of enthusiasts who seek to foster and promote all phases of gliding and soaring on a national and international basis. The association is a member of the Aero Club of Canada (ACC), the Canadian national aero club representing Canada in the Fédération Aéronautique Internationale (FAI), the world sport aviation governing body composed of national aero clubs. The ACC delegates to SAC the supervision of FAI-related soaring activities such as competition sanctions, issuing FAI badges, record attempts, and the selection of a Canadian team for the biennial World soaring championships.

*free flight* is the official journal of SAC.

Material published in *free flight* is contributed by individuals or clubs for the enjoyment of Canadian soaring enthusiasts. The accuracy of the material is the responsibility of the contributor. No payment is offered for submitted material. All individuals and clubs are invited to contribute articles, reports, club activities, and photos of soaring interest. A 3.5" disk copy of text in any common word processing format is welcome (Macintosh preferred, DOS ok in ASCII). All material is subject to editing to the space requirements and the quality standards of the magazine.

Prints in B&W or colour are acceptable. No slides please. Negatives can be used if accompanied by a print.

*free flight* also serves as a forum for opinion on soaring matters and will publish letters to the editor as space permits. Publication of ideas and opinion in *free flight* does not imply endorsement by SAC. Correspondents who wish formal action on their concerns should contact their SAC Zone Director whose name and address is given in the magazine.

The contents of *free flight* may be reprinted; however, SAC requests that both the magazine and the author be given acknowledgement.

For change of address and subscriptions to non-SAC members (\$20 per year, US\$22 in USA, and US\$28 overseas), please contact the National Office, address below.

<b>President</b>	Pierre Pepin
<b>Vice President</b>	Harald Tilgner
<b>Executive Secretary</b>	Joan McCagg
<b>Corporate Treasurer</b>	Jim McCollum
<b>Corporate Secretary</b>	Joan McCagg

**SAC National Office**  
Suite 111, 1090 Ambleside Drive  
Ottawa, ON K2B 8G7  
(613) 829-0536 Fax (613) 829-9497

Deadline for contributions:

**5** January, March  
May, July  
September, November

est une organisation à but non lucratif formée de personnes enthousiastes cherchant à développer et à promouvoir le vol à voile sous toutes ses formes sur une base nationale et internationale. L'association est membre de l'Aéro Club du Canada (ACC) représentant le Canada au sein de la Fédération Aéronautique Internationale (FAI), administration formée des aéro clubs nationaux responsables des sports aériens à l'échelle mondiale. Selon les normes de la FAI, l'ACC a délégué à l'Association Canadienne de Vol à Voile la supervision des activités de vol à voile telles que tentatives de records, sanctions des compétitions, délivrance des brevets de la FAI etc. ainsi que la sélection d'une équipe nationale pour les championnats mondiaux biennaux de vol à voile.

**vol libre** est le journal officiel de l'ACVV.

Les articles publiés dans **vol libre** sont des contributions dues à la gracieuseté d'individus ou de groupes enthousiastes du vol à voile. Le contenu des articles soumis est la responsabilité exclusive de leurs auteurs. Aucune compensation financière n'est offerte pour la fourniture d'un article. Chacun est invité à participer à la réalisation de la revue, soit par reportages, échanges d'opinions, activités dans le club, etc. Le texte peut être soumis sur disquette de format 3.5" sous n'importe quel format de traitement de texte bien que l'éditeur préfère le format Macintosh (DOS est acceptable). Les articles seront publiés selon l'espace disponible. Les textes et les photos seront soumis à la rédaction et, dépendant de leur intérêt, seront insérés dans la revue.

Les épreuves de photos en noir et blanc ou couleur sont acceptables. Les négatifs sont utilisables si accompagnés d'épreuves. Nous ne pouvons malheureusement pas utiliser de diapositives.

L'exactitude des articles publiés est la responsabilité des auteurs et ne saurait en aucun cas engager celle de la revue **vol libre**, ni celle de l'ACVV ni refléter leurs idées. Toute personne désirant faire des représentations sur un sujet précis auprès de l'ACVV devra s'adresser au directeur régional de l'ACVV dont le nom apparaît dans la revue.

Les articles de **vol libre** peuvent être reproduits librement, mais la mention du nom de la revue et de l'auteur serait grandement appréciée.

Pour changements d'adresse et abonnements aux non membres de l'ACVV (\$20 par an, EU\$22 dans les Etats Unis, et EU\$28 outre-mer) veuillez contacter le bureau national à l'adresse qui apparaît au bas de la page à gauche.

**EDITOR**

Tony Burton  
Box 1916 Claresholm, Alberta T0L 0T0  
tel & fax: (403) 625-4563

Any service of Canada Post to above address. Commercial courier service, c/o "Claresholm Local Press".

**COMMERCIAL ADVERTISING**  
National Office (613) 829-0536

Date limite:

**5**

janvier, mars  
mai, juillet  
septembre, novembre

# letters & opinions

## AIR CADET FLIGHT TRAINING

Having read George Eckschmiedt's article on Accident/Incident reports in the April/May issue of *free flight*, I feel I must respond to what George calls a "touchy subject" — Air Cadet glider pilot training. I myself am a former Air Cadet and a recently retired airline pilot, as well as a Class I glider instructor and Chief Towpilot at Gatineau Gliding Club.

Unfortunately what the Air Cadet movement is doing, and what it has done, has been greatly misunderstood by many, especially as far as the flying program is concerned. The aim is to provide an "air" experience to all cadets. This is done by giving a "familiarization flight" to all. The very keen and deserving can take a full winter's ground school course followed by an exam in the spring which is nationally set. Those with good marks are then interviewed and those who are considered the most suitable are selected for the flying or gliding program on the basis of the exam, interview, school marks, and other criteria.

Those in the gliding program are trained to the minimum standard prescribed by Transport Canada for a licence, which means, basically, a circuit. They get the usual flights covering spins, spirals, steep turns, etc, but the bottom line is they are trained to fly a circuit — not SOAR. Also, all of their training is done on a 2-22 or 2-33 only.

Cadets who show great keenness at this stage can fly one or two flights solo on ideal weather weekends at various sites until a minimum 10 hours solo has been completed. These are the cadets who become passenger rated to take other cadets up on "fam" flights. Once a senior cadet or young officer has sufficient experience, he or she may eventually become an instructor, and many of these instructors, I venture to say, have rarely been out of the circuit. It would certainly be nice to have Air Cadets qualified to the standard we expect in our clubs, but time, money and sheer numbers will not allow this to happen.

At GGC, when Air Cadets show up, we discuss their past training with them and encourage them by giving them the objectives of further training so that they look forward to becoming free soaring pilots able to leave the circuit with confidence.

As far as accidents are concerned, during the ten year period 1984-1993 the cadets had 540,000 launches with only 39 glider and 9 towplane accidents where major repairs or replacement was necessary, as well as 85 glider and 49 towplane incidents involving minor or no repair — an impressive record.

Very few citizens realize the many advantages of the Air Cadet movement to the youth of our country, not the least of which is the chance to learn to fly gliders and/or powered aircraft at a very small token charge only. The Air Cadet movement has been giving flying training to Air Cadets since 1946 and also, since 1965, gliding training, and currently trains approximately 570 cadets per annum to licence level on powered aircraft and gliders.

One will find ex-Air Cadets in all facets of the field of aviation in Canada, and the Royal Canadian Air Cadet movement and its civilian co-sponsors, the Air Cadet League of Canada, is considered by other nations of the world to be the optimum of all youth organizations.

**Bob Mercer**

Chairman, Air Cadets committee

## BRONZE BADGE RED TAPE?

Are the changes to the Bronze badge published in *free flight* 3/94 really for the best? The spot landing requirement, in particular, looks dangerous. If normal approach speed (eg. 1.3 Vs + Vw) is maintained to the threshold, many modern sailplanes cannot be stopped within 150 metres of the threshold. My Pilatus B4 (not a hot ship), in a light wind, requires almost 200 metres. (Yes, I've measured it.) I'm sure that the 1-26 can be stopped in 150 metres, but its behaviour is not typical.

An aspiring cross-country pilot should be required to show an instructor that he or she can judge the circuit so as to arrive consistently between 5 and 10 metres over the threshold (1 metre is too close!) within 5 mph of normal approach speed and with spoilers open. Such an approach will produce the minimum landing roll consistent with safety. To reward very short landings is to encourage the pilot to fly below normal approach speed, and too close to the fence, and that is dangerous.

The Bronze badge is supposed to encourage pilots to continue on to the FAI badges by showing them the pleasures of advanced soaring. It is now necessary to collect a dozen signatures to get the Bronze badge. My Diamond badge legs didn't require this mass of red tape! Worst of all, a pilot who doggedly collects all the signatures will feel entitled to go cross-country, even though he or she may be lacking the necessary attitude, or aptitude, to do so safely. Wouldn't we be better off if we simply respected the CFI's assessment of the pilot's readiness for cross-country flight?

continued on page 17



# FRONTS

Here, to refresh the memory, is an illustrated summary of some frontal characteristics.

**Tom Bradbury**  
from *Sailplane & Gliding*

**Basic fronts** There is always a temperature gradient between the cold polar regions and the hot tropical zones. When a convergence line develops the temperature gradient is intensified making a sharp boundary between the warm and cold air masses. Figure 1A shows a surface flow giving convergence between the cold northerlies and warm southerlies. The dashed lines are isotherms (lines of equal temperature) which become concentrated by this low level convergence. Figure 1B depicts the high level flow. It shows a region of divergence caused chiefly by the upper winds accelerating away. Figure 1C is a vertical cross-section combining the low and high level patterns.

When convergence below and divergence aloft are combined in the same area it results in low level air being drawn upwards. During ascent the warm air rises over the cold because it is less dense. The boundary between the air masses is called a front.

On small scale met charts a front is usually drawn as a single line; large scale diagrams reveal it as a more gradual change. Figure 2 shows a vertical section through a front which crossed the British Isles. The front is marked by a pair of lines sloping upwards from right to left. These lines separate the two air masses and show the width of the frontal zone where they merge. Isotherms slope downward from right to left with a marked kink where the frontal zone intervenes.

**Tropopause changes** The heavy black line marked tropopause shows the boundary between the stratosphere aloft, where the temperature changes little with height, from the troposphere below where the temperature almost always decreases with height. The tropopause dips down when flying from warm to cold air. There may be a downward flow of air at this point bringing very dry stratospheric air down below the warm front. The motion of this stratospheric air has been traced by measuring the con-

centration of ozone. Ozone is formed in the stratosphere and (generally) destroyed low down. Extra ozone in the upper frontal zone usually indicates downward penetration of stratospheric air.

**Cloud structure** Figure 3 shows the kind of cloud often produced by the upslope motion over a frontal surface. Ascent cools the air leading to condensation of moisture; this produces cloud and eventually rain (or snow). The slope of the frontal surface may vary between about 1:50 and 1:200 depending on the temperature contrast and the wind structure. This diagram greatly exaggerates the slope.

Approaching the front from the cold side the first signs are high level cloud in the form of cirrus. Cirrus consists of ice crystals which can refract the sun's rays to produce various kinds of halo. Going further towards the front the cirrostratus thickens and lowers to form altostratus. This is formed from water droplets even though the temperature at that level is far below freezing. The cirrus halo is then lost but the sun may still be visible if the altostratus is fairly thin. Nearer the surface front the cloudbase continues to descend and low stratus develops, particularly in regions over and near the sea. Hills are often hidden by the low stratus. Far inland the lowest cloud often burns off by day in summer.

**Time variations** Figure 4 shows how an originally almost straight front can develop with

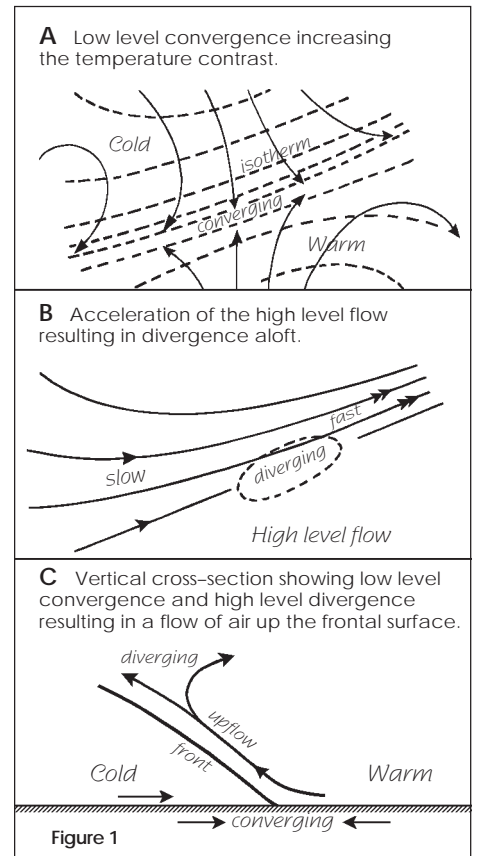

Figure 1

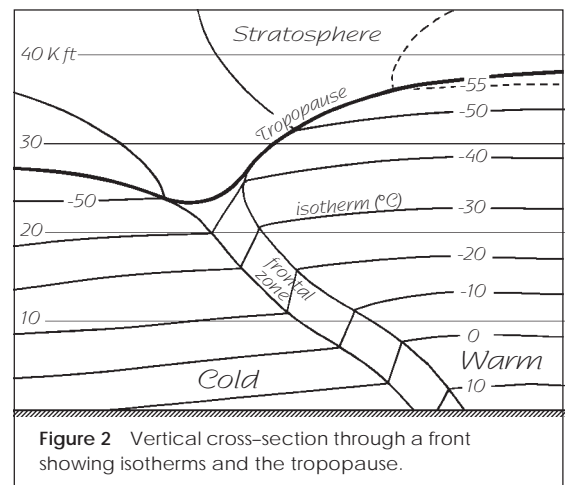

Figure 2 Vertical cross-section through a front showing isotherms and the tropopause.

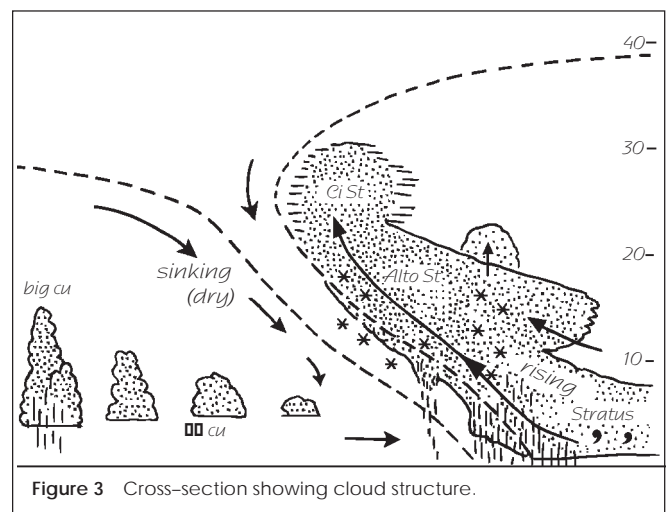

Figure 3 Cross-section showing cloud structure.

time. Each stage is separated by about half a day. At the top A shows a quasistationary front marked with alternate blobs and spikes. The warm air lies south of this dividing line. B shows an undulation in the front. It usually develops in association with a shallow surface depression. On the right the line travels northeastwards as a warm front; on the left it moves southwestwards as a cold front. The cold front often travels more rapidly than the preceding warm front and the kink between the two becomes more marked in C. The surface low has usually deepened since stage B.

Eventually the cold front overtakes the warm front to form a system called an occlusion. When a front becomes occluded as in D the warm air is lifted from the surface. Quite often the beginning of an occlusion coincides with the period of maximum deepening of the associated surface low. When deep surface lows slow down the occlusion becomes wrapped round the centre, as in E. Far away from the low the cold front

slows down too and is called a "trailing" cold front.

The last stage F shows the trailing cold front developing a new wave on it. This takes us back to stage B and the whole process can be repeated. In bad summers a large and slow moving depression gets stuck to the west of Scotland and successive new waves form on the cold front over the Atlantic. One rain belt has hardly cleared eastern Britain before a new one develops and sweeps in from the Atlantic to take its place.

#### Undulations on the frontal surface

The frontal surface does not have a constant slope; it may level off and even dip slightly. Figure 5 shows an example of a cloud gap which developed where the frontal surface flattened out. Here the upward motion was interrupted and a wide break developed in the high cloud layer. This allowed the sun to come through and revive the cumulus clouds which had dispersed below the high clouds.

#### Anafronts and katafronts

Fronts can also be classified by the air motion up or down the frontal surface. If the air rises up the frontal surface it is called an "anafront". Anafronts are active systems because ascent of air produces deep cloud masses with much rain. The reverse is a "katafront". Here the flow is downwards warming and drying the air and dispersing much of the cloud. A long front extending a thousand miles or more will often have some

surface. In other cases a complicated process (which I find too difficult to describe) may produce rolls with their axes of circulation almost parallel with the frontal surface. Figure 6 illustrates these. The rolls are shown end on; they extend into the diagram. Rolls can be contra-rotating, rather like the longitudinal rolls under cloudstreets. This results in extra up and down motion above the frontal surface producing bulges in the cloud top. It also affects the rainfall. Instead of one uniform area of rain you get several bands of heavier rain.

#### Cloud seeding

The air in and just below a frontal zone is normally stable (since cold air is capped by warm air). However the warm air above the frontal surface may be "potentially unstable". This can occur if the air aloft is very dry. When potentially unstable air is lifted it first cools at the dry adiabatic rate of 3°C per 1000 feet. If the lower layers were already moist they soon become saturated and the rate of cooling is reduced to the wet adiabatic rate. The much drier air above continues to cool more rapidly at the old (dry) rate. This change of lapse rate between the wet air low down and the dry air just above it can make the air absolutely unstable as soon as it becomes saturated.

The first signs are the appearance of cumulus turrets building through the layers of stratiform cloud. These turrets then produce showers of ice crystals which fall down into the layer below. Dropping ice crystals into clouds is called "seeding". Clouds have been artificially seeded for many years. "Rain making" was once a popular activity — experimenters tried to increase rainfall by dropping "dry ice" into clouds. Trials showed that artificial seeding of a moderate sized cumulus cloud stimulate it to grow into a cumulonimbus.

At warm fronts the seeds of ice crystals grow in the saturated air and produce trails of precipitation starting as snow and turning into below the freezing level. The process is illustrated in Figure 7. The cu turrets form

the "generating cells" from which ice crystals fall to seed the stratiform cloud below. The frontal rain is thus broken up into bands or clumps of heavier rain. On this diagram the freezing level is shown by a dashed line marked with a zero. As snow descends past this line it changes into rain and falls much faster. The diagram shows how the angle of precipitation alters where the snow thaws.

#### Pressure tendency and frontal activity

Changes of pressure can give an indication of frontal activity. With a typical moderately active front the surface pressure starts to fall many hours before the front arrives. If the front is weakening the fall of pressure is usually delayed; in some cases the pressure may continue to rise. Rising pressure near the front usually means that the air

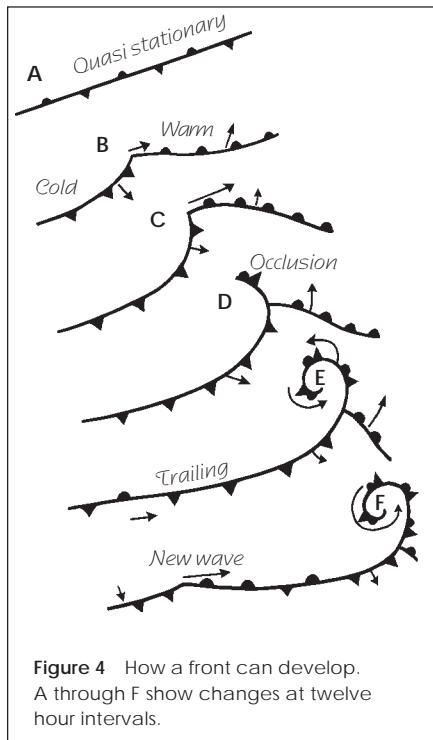

Figure 4 How a front can develop. A through F show changes at twelve hour intervals.

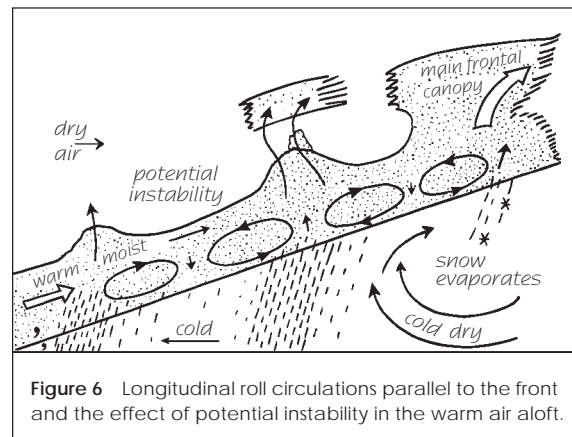

Figure 6 Longitudinal roll circulations parallel to the front and the effect of potential instability in the warm air aloft.

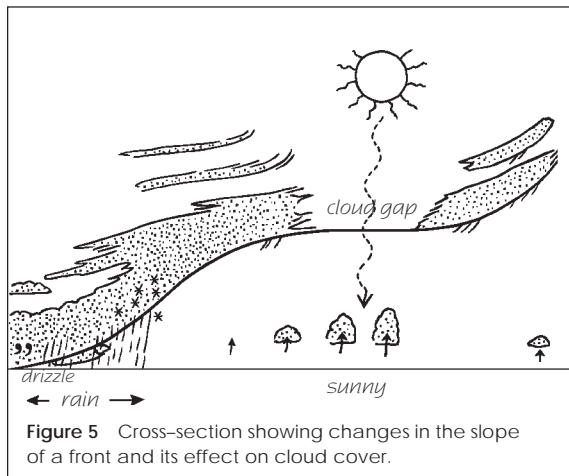

Figure 5 Cross-section showing changes in the slope of a front and its effect on cloud cover.

active sections which are anafronts and other weaker parts which are katafronts.

#### Frontogenesis and frontolysis

These are two more terms to indicate changes taking place. Frontogenesis means a front is forming or becoming more vigorous. Frontolysis is the opposite, meaning the front is weakening. When the old front has decayed completely it is said to have been "frontolyzed".

#### Complicating factors

**Longitudinal circulations** On some fronts the warm air smoothly ascends the frontal

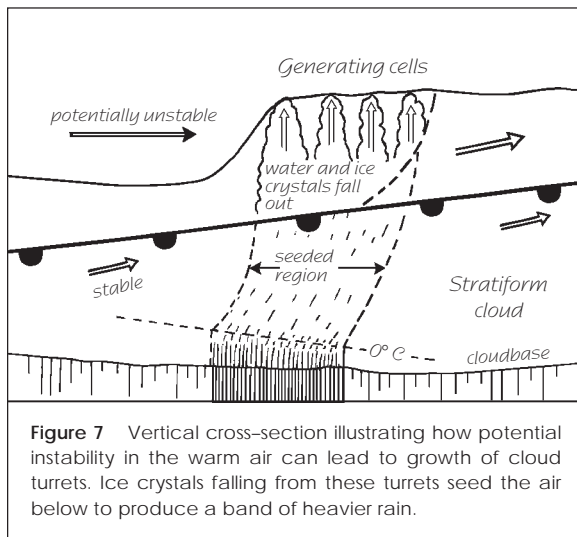

**Figure 7** Vertical cross-section illustrating how potential instability in the warm air can lead to growth of cloud turrets. Ice crystals falling from these turrets seed the air below to produce a band of heavier rain.

aloft is subsiding. This precedes thinning and dispersal of the upper cloud layers. If pressure continues to rise in the warm sector there will probably be at least a couple of days fine weather, sometimes more.

A clubhouse barograph is the best indicator of pressure change but one can get a useful guide from noting the change of ground based altimeter readings. If the altimeter shows an increase of height the pressure is falling, and vice-versa. However, pressure change alone is not too reliable as a guide.

#### Variations along a warm front

Fronts are normally most active near the centre of low pressure. It is here that the upward motion is strongest. Towards the centre of high pressure the air aloft is usually found to be subsiding and hence becoming warmer and drier aloft. If you fly towards an anticyclone the cloud thins out into layers instead of being solid. Then the upper layers dissolve as the air dries out. Finally nothing remains except a zone of low stratus to mark where the front lies. Figure 8 illustrates the process.

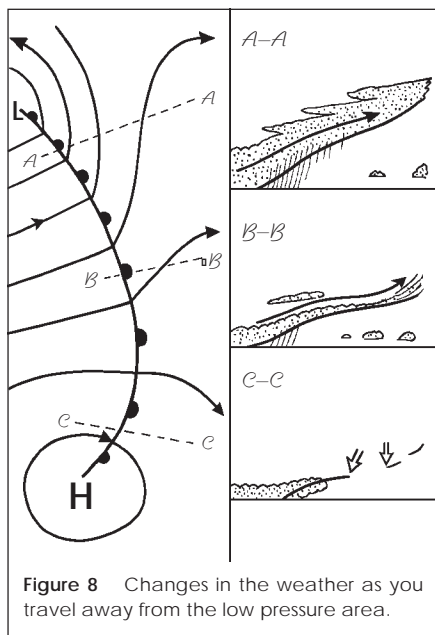

**Figure 8** Changes in the weather as you travel away from the low pressure area.

#### Dangers of hill fog

Near most fronts the air is usually very close to saturation. Even a small amount of lifting is enough to produce a cap of cloud over hills before the front arrives. After a warm front has passed the cloud may be low enough to produce fog over the sea and windward coasts as well. Cloud covering high ground has led to hundreds of aircraft accidents in the past (*Hope, BC is a notorious example. ed*). Although there are more navigation aids nowadays, aircraft still fly into hills. Gliders are less likely to be involved but only because their pilots seldom take off if the weather looks unsoarable. Powered aircraft tend to get caught out when pilots try to beat the incoming front, or find they have to let down through solid cloud.

When low down the grey layer of low stratus is sometimes hard to see against an equally grey layer of altostratus. A layer of thick haze can also make it difficult to notice low stratus. One may only realize there is a layer of lower cloud when another aircraft suddenly disappears from view.

Some mountains seem to collect numerous wrecks. Years ago when I used to walk over Snowdonia I came across many twisted fragments of old aircraft on ridges and in gulleys. The RAF station at Valley used to keep a map of all wrecks, partly to reassure people who rang up to say they had found bits of aeroplane. In my time the map had at least one hundred known wrecks marked, many dating back to the war years. The Scottish mountains have claimed a number of victims too but it is not only the high peaks which take their toll. Even quite gentle hills such as the Downs and Isle of Wight have their quota of wrecks.

#### Signs in the sky

**The approaching warm front** Long before any threatening layer of cirrostratus appears one may see filaments of cirrus. Some of these appear as hook shaped clouds. When they start to increase they are called "mares' tails". Occasionally one may see how they form. At high altitude short-lived puffs of cloud appear looking like icy cumulus. These release ice crystals which trail back in the strong windshear producing very long filaments of cloud. The generating puffs usually vanish so quickly that one does not notice them before the cirrus hooks appear.

Dense cirrus streaks can appear near the edge of a jet stream well ahead of the main cloud sheet. They usually travel very rapidly. These streaks suggest the air aloft is becoming moist.

**Contrails** Thickening condensation trails are another sign that the air is becoming moist at high levels. Most contrails form when the moisture from aircraft engines con-

denses in the upper atmosphere where the pressure and temperature is too low to hold the excess water. Jets, with their much hotter exhausts, start trailing at lower temperatures than piston engines. In both cases the trails evaporate in very dry air but thicken and persist when they meet the previously invisible moisture ahead of a warm front.

**Haloes** Haloes are a sign of cirrostratus. This cloud can start by being so thin that the blue sky shows through. A 22° halo around the sun is a fairly common type — 22° is the angle of minimum deviation when light passes through a prism of ice with sides at 60°. Many ice crystals are hexagonal prisms and alternate faces of a hexagon are inclined at this angle. A second, 46° halo can also appear. This is due to ice prisms with faces at right angles. Fresh new cirrus can produce many more patterns with arcs of contact and mock suns.

The leading edge of the main cirrostratus sheet may be as much as 500 miles ahead of the approaching surface front but quite often the distance is only about 300 miles. Cumuli keep going in the unstable cold air ahead of the warm front but dry air sinking down under the front often limits the cu tops. Even when the cu themselves vanish there may still be thermals under the cirrus.

#### How thermals change character

When cirrostratus spreads over the sky thermals may change character. Until the cirrus arrives many thermals have sharp edges so that one immediately feels the surge of lift on entry. When a thick cirrostratus sheet spreads over during the heat of the day the effect is as if the time had jumped and evening was near. Thermals lose their sharp edge and feel softer and smoother. The rapid change may be disconcerting; it can take a little while to slow down and adjust to the new feel of lift. One gets the impression that thermals have become more widely separated and cautious pilots feel an urge to work every thermal to the very top in case there will be no more.

Provided the top cover does not arrive until well after midday the ground often gets enough heat to maintain thermals even when the cirrus has changed to thin altostratus. A gap in the upper cloud sheet, possibly formed where the frontal surface flattens out allows the cu to build up with renewed vigour. Breaks in the advancing upper cloud sheet are not uncommon; this is an encouraging thought if one is obliged to fly under the frontal cloud to get home.

Sometimes the cold air is so unstable that convection continues even under thick altostratus, and active cumulus can persist until the frontal rain is only a few miles away. In one example, the altostratus sheet had lowered to about 8000 feet and weak wave activity began to show up over some of the cu tops. Fronts quite often stimulate some wave activity. Some satellite pictures show long waves on the top of frontal cirrostratus but the cloud layers are usually too thick for wave soaring.



# BC Safari Diary

**Mike Thompson**  
Vancouver Soaring Association

**T**HIS YEAR we flew the fifth BC Soaring Safari in a row for VSA members, historically held over the first two weeks of June. One of the objectives is to fly between as many airports and stops as possible during the two week period. In the early years we would plan lots of stops, but in the end found that it was better to spend more time at fewer places. This year we decided to go east to the Rockies by way of a northern route. We would start at Pemberton, fly over the Coast Range to Lillooet, then on to Salmon Arm, Golden, and finally to Invermere. The leg from Pemberton is short, but has no off-field landing possibilities other than lakes. The leg to Salmon Arm has lots of fields and the leg to Golden has landable fields only for the first third. By the end of the safari, all legs were flown.

**Saturday May 28** VSA's second weekend at Pemberton. The weather wasn't too good, and not much flying was done. Last weekend Dave Baker flew to Lillooet and back.

**Sunday** Again the weather wasn't good. Conditions make a flight to Lillooet not possible. This was to be the actual start of the Safari, and as has been done in the past, we trailered to the first away airport. The plan was to stay at Lillooet for two days, and then move on to Salmon Arm for three days. We then spent four days in Golden, and four days in Invermere before coming home.

**Monday** Lillooet has a very nice airport; the strip is 75 feet wide and 4000 feet long, shoulders on each side of the airport are around 60 feet wide and are kept freshly mowed. Camping is allowed at the airport, and a small terminal building has a telephone, restroom and running water.

The day appeared very promising. Joe Gegenbauer flying Y3 (ASW-20B) and Mike Thompson flying XH (HP-14) got away shortly after launch and flew to Clinton and Cache Creek, before returning and exploring near the airport. Cloudbase was over 11,000 feet, with regular 8+ knot thermals. A nice cloudstreet went right over Pavilion Pass leading to Clinton. Dave Burgess and Angus Livingstone in P5 (Libelle) both had good flights. Heidi Popp, Kalli Brinkhaus, and Ian Chaun flew the Grob 103, PP (plastic pig) and had good flights. We were all very impressed with this site, and with the cooperation of the airport manager.

**Tuesday** The cirrus that blew in late in the day yesterday, has now been followed up by heavy stratus and cool air. We decided to look around the area, and only one flight was done by PP. Dave Burgess and I drove into town for a swim at the community centre, and then inspected an old, now disused suspension bridge. We spent nearly two hours studying its design. We then had lunch and drove around looking at off-field landing sites. The original plan was to move on today, but we all liked this spot so much that we decided to stay for another day. The weather looked good for the next day, so we may be able to try flying cross-country to Salmon Arm.

**Wednesday** The weather was now cooperating quite well. Around 1300 I launched and was off tow at 2000 feet. The lift was incredible, and I gained more than 4000 feet before the towplane landed. Dave Baker flying Y3 and I decided to leave very soon after launch. We had originally been asked to wait for Ian in PP and Angus flying P5 to catch up so that they could take some air-to-air photos. But as soon as Dave and I got together, we left as the conditions looked very good, and some over-development looked as if it could shut us down later. In the end Y3 and XH made it to Salmon Arm, a really nice cross-country flight of 190 km. Angus flew to Cache Creek and was picked up by his crew. The crews took several hours to show up, and in the meantime we went for dinner at a local pub.

**Thursday** The weather was still cooperating, and several good flights were made near the airport. In the late afternoon, high cirrus again cut off the sun, and the lift stopped. At Salmon Arm, the strip is paved, but there are runway lights and more traffic than at Lillooet, including some commuter airline traffic. We were greeted by the airport manager who gave us the combination for the clubhouse, which had a shower and a small self-serve bar.

**Friday** The morning weather didn't look too good, but the afternoon forecast brightened my hopes. Our plan for the day was to try and fly cross-country to Golden, that or trailer. Joe launched in Y3 with XH and P5 right behind. Angus in P5 and myself got away together, with Joe about 15 km ahead. The conditions were getting better all the time, and with a forecast 14 km tailwind, we made good progress. The route took us first to Sicamous and the last landable fields, then on to Revelstoke, where there is at least an airport. From Sicamous to Revelstoke, the entire flight was over mountains. Angus decided to stay at Revelstoke, and Y3 and XH pressed on. The next section was over Rogers Pass. The photo was taken over the pass looking north. Many of the peaks in this area are over 11,000 feet, so we were thankful for a 12,000 feet cloudbase. Just for fun, there was a 15 mile wide blue patch right at the top of the pass. In the end Y3 and XH made it over the pass, and into the Golden area. With excellent conditions, we spent the next several hours flying in the Golden area, with Joe



Mike Thompson

going over to Lake Louise, and then he joined several of us and we headed up into the Freshfield Glacier area. (Mike said the thermals coming up off the treed slopes were strong enough to rip the squirrels right out of the branches. That's a great line — Tony)

**Saturday** Rain started in the early morning, and stopped any flying for the day. We spent the day doing laundry, and hanging around Rocky Mountain Soaring Centre.

**Sunday** This turned out to be a good day, and lots of good flying was done. Tony and Ursula and Trevor Florence joined us.

**Monday** Another rainy day.

**Tuesday** An overcast day, although conditions did improve in the afternoon. Several of us decided to fly the rental Ka6CR.

**Wednesday** A rainy day. Several people trailered on south to Invermere, and the rest of us would follow tomorrow.

**Thursday** Fairly good weather, Trevor did a 300 km flight for his Diamond goal, and the rest made cross-country flights about as long, but undeclared.

**Friday** The Y3 crew left this morning. The weather was not too bad, and several cross-countries were declared. The upper level winds played havoc with the thermals, however, and it turned out to be a fairly rough day. Trevor came close to doing a 500, only cut short by the next system coming in. To the south some cloud moved in, cutting out the sun, and lots of lennies were moving around and also cutting out the sunlight. The wind was strong enough that cu forming on the west side of the valley had their tops blown off and shaded the east side of the valley.

A successful safari is over, and on Saturday we trailered back to Hope — it's windy with lots of cu and lennies overhead. •

# 1994 Nationals

## Contest weather can only improve from here

**Stephen Liard**  
SOSA

**H**OT... HAZY... HUMID! Welcome to the start of the 1994 National Soaring Championships at Rockton, Ontario.

With a hot humid airmass lying over southwestern Ontario, the outlook for good soaring conditions throughout the first week of the Nats was less than ideal. The air stability was middling to high, with cloudbases barely reaching 3000 feet agl. And at this height, pilots were reporting severe haze and visibility problems on many days.

*Monday, July 4* The last chance for the visiting pilots to practise finding SOSA from the air. The east wind brought in the lake effect from Lake Ontario and barely sustainable thermals to under tow height, but launches were made on the off chance that some of the close turnpoints could be checked out. The countryside was extensively cropped, with few good outlanding fields. Tony Burton in EE had the dubious honour of the first landout seven kilometres downwind in a chicken breeding station, and he wasn't allowed to use the phone because of the risk of carrying some germs to the birds. "Not even the boss gets in here without going through the shower first", said one of the employees.

*Tidbit:* Chris Eaves, who produced the turnpoint data for the contest, missed a golden opportunity for selecting the most colourful TP name when he didn't include Punkydoodles Corners.

*Tuesday* The first official contest day was scrubbed by 1300 when a sticky southwest wind and overlying stratus deck wouldn't clear. However, the 1800 foot ceiling did provide enough height for Eddy Hollestelle to do a beat up of the field for the local CTV affiliate.

*Wednesday* Bernie Palfreeman, who gave the meteorological forecasts throughout the contest had little good news to greet the pilots. A continuing southwest flow provided very high humidity levels that peaked at midday. Moist and unstable at higher levels, and stable at lower levels meant that there would be difficulty in achieving minimum cloudbase.

To explain the minimum cloudbase requirements, Contest Director Larry Springford had set some basic guidelines. "I was looking to run a safe and competitive Nationals. I had set a cloudbase height of 3000 feet agl as the minimum safe height that I would consider for a contest day. This would give the competitors the best chance of safe cross country flying without undue low thermalling."

Standard Class pilot Jörg Stieber in his LS-4 was one of three pilots to tie for furthest distance with Ulli Werneburg in an ASW-20B and Heri Pölzl in an LS-6. Jörg describes the day and the task:

"The weather was hot and humid with 3-5 nautical mile visibility and low cloudbase. Thermal strength was forecast to be 1-3 knots. The task was north to Arthur and return, the shortest of our three alternatives at 126 kilometres.

After launch I had trouble climbing up to cloudbase. When I finally got there it was at 2700 feet agl with very poor visibility, less than legal VFR limits. The opening of the start gate had to be postponed because the CD had decided not to send the field out on course if they could not get to at least 3000 feet agl. Eventually conditions improved somewhat and I started at 1520, approximately 30 minutes after start gate opening. I left with some of the 15 metre gliders. A number of Standard competitors, as well as 15 metre ships were already on course.

I got the first bitter lesson of the day as I headed towards a small gaggle under a good looking cloud over Puslinch Lake. When I arrived, the lift was just dying and the gaggle, by then at cloudbase, pushed on. Obviously the thermals were to be very short lived and unless one got to a cu when it was forming, it was too late.

Seeing gliders thermalling ahead, I decided to press on across Hwy 401 towards Guelph despite being uncomfortably low. I joined the first glider and took two turns yielding only a half to one knot. When T2 passed through the thermal and kept going towards

the next cloud I followed. I headed for the spot where I saw T2 gaining good height in a pull-up and decided to try a turn although T2 had pushed on. To my surprise I hit solid 3+ knots, nice and steady. I took what turned out to be my best thermal of the day all the way up to cloudbase at 3500 feet agl. With confidence boosted by the good climb I was not too concerned over the soft conditions and ragged clouds north of Guelph. Weak conditions are not unusual for the area between Guelph and Belwood Lake. I found some weak lift here and there which was hardly worth stopping for.

Finally I caught up with a large gaggle north of Belwood dam and was delighted to find myself in the company of a number of very good 15 metre pilots. But the lift was weak, around half to one knot. Gliders lower in the gaggle headed for fields and it looked grim to the north with the cirrus moving in from the west. Certainly not the situation to be charging ahead. Carefully conserving altitude, I followed when the top of the gaggle moved north. Under the influence of the overcast, every thermal was weaker and lower than the previous one while the ground elevation was rising. The return to Rockton became an impossible dream.

Over Arthur there was nothing but dead air. Four gliders landed directly at the airfield while MZ, KC and myself decided to get a little extra distance by rounding the Arthur turnpoint before landing. On the ground the disappointments continued. First there was no beer in the club fridge, then we found out the day was only worth 86 points in Standard Class and a whopping 142 points in 15m."

So on the first flying day, 100% of the competitors had landed out with distances ranging from a high of 64.4 km to a low of 25.8 km. The Nationals was underway.

*Tidbit:* Wilf Krueger suffered some camera timer problems and considered withdrawing from the contest. Fortunately for him, he didn't.

*Thursday, July 7* This was to be a virtual repeat of the Wednesday forecast, but with

even lower cloudbases. Both the 15m and the Standard Classes launched, but by 1500 the CD had scrubbed the day due to an insufficient ceiling. There had been hopes that the base would lift during the day, but it was not the case. One could almost say "ditto" for Friday, but the CD scrubbed the launch before noon. The highlight of the day was local Hamilton TV station CHCH. They broadcast a live remote from SOSA Gliding Club with three or four segments throughout their noon newscast. Lots of static shorts but no flying scenes at all.

**Tidbit:** Paul Thompson was heard plotting on his crew frequency on the exact location of the CD as he had a well-placed ballast dump in mind prior to landing.

**Saturday** Some cold air advection aloft up to 3000 feet agl had dropped the air-mass stability somewhat. But a cold front passage had depressed the surface temperatures. Jim Oke arrived from Winnipeg after a car trouble delay and Richard Longhurst finally got his SZD-55 legal. Everyone launched and Flying Day Two was underway. Ulli Werneburg tells the tale:

"After a series of unflyable days and one day (the first official contest day) which was barely flyable, we finally got a day which looked reasonable. However, there was still a lot of moisture around, on the ground and at various levels of the atmosphere, in addition to an approaching front from the west. Because we were actually between two fronts, we had a very strong wind from the southwest. Cumulus formed early and before takeoff I already observed a certain amount of spreading out of the cumulus.

The day's task was a three hour POST and once in the air we immediately realized that the poor visibility of the past few days had improved significantly. I found that I could climb with my water ballast and decided to make a relatively early start, being afraid of overdevelopment. I decided to go upwind first, taking advantage of a cloud-street heading off to the southwest. Near the Grand River 20 kilometres out, the cloud-street ended and I decided to fly cautiously to Brantford, which had more sunshine than other areas. I bumped along in indifferent lift, circling as little as possible because of the strong wind. Near Paris I climbed to 2700 agl and headed slowly to the turnpoint at Brantford airport. Eventually I arrived there with 2500 feet just in time to watch DM land on the apron. Now I was uncertain about my next turnpoint and at first went back towards Rockton, with thoughts of going to Guelph. Then I saw another cloud-street which was heading west so I decided to try and go NNW to Ayr. Progress was very slow but I was glad to have my water.

Northwest of Paris I got down to 2000 feet but finally contacted another dark looking street which headed west. This brought me a couple of good thermals and the Ayr turnpoint. I was tempted to keep on going WSW to Woodstock but could see that the cloudstreet ended short of it and that the

sky was going completely overcast in that direction. So I chickened out and headed back to Rockton. I was there in a down-wind flash but unfortunately it was a dead area. Also, the overcast was now practically everywhere.

I decided to try and get at least to Reid's field (15 km north) and back. On the way I got a good climb to 3000. After the turnpoint I met up with 3B and 77 and got another good climb and watched two gliders landing at Reid's. The three of us headed for Cambridge in an attempt to reach Ayr again. However the overcast was very solid now and the lumps of clouds underneath it were practically dead. I had been flying for only about 1:40 hours, so what to do now? I prudently flew back to Rockton with no other plan except to stay up and await developments. Unfortunately, the only development was that I couldn't stay up so I dumped my water ballast and landed at Rockton after a task time of about two hours.

The total distance I flew turned out to be just under 100 kilometres — not exactly earth shaking. However, at least I landed back at Rockton and due to the efforts of 3B, 77 and K2 who all flew over the minimum 50 kilometres (3B made almost the same flight as I) the 15m Class at least had a contest day but alas, the winning point total was only 200 — a small reward for a lot of struggling. However, the Standard Class was rewarded even less since they did not have an official day."

As both classes required at least three pilots to exceed 50 kilometres, the Standard Class had come close. Jörg Stieber (JS) flew 63.1 and Ed Hollestelle (XT) made 64.0 kilometres. Fred Hunkeler (1M) finished with a distance of 47 kilometres. Thus by only three did the Standard Class miss a contest day, and this turned out to be a critical shortfall.

**Tidbit:** When a pilot went into the clubhouse john before the launch of the grid, he overheard both Ed and Jörg, who were the flying members of the Task Committee, discussing changing the day's task while cloistered in adjoining stalls.

**Sunday, July 10** "Launch the Standard Class!" A cold front had passed over Rockton at 0730 resulting in solid overcast until 1330. At 1500 conditions had improved somewhat but we were still plagued by low cloudbase. Larry decided to scrub the gridded 15m Class but launch the Stand-

ards in an effort to get them a second contest day. They launched at 1510 and by 1600 the gate opened for a two hour POST. Despite valiant efforts and many landouts, only Ian Spence in WW made scratch distance, completing 89.8 kilometres at 44.9 km/h, thus the effort was again in vain.

The forecast for tomorrow looked good though, and the morning pilots meeting was moved up an hour in anticipation.

**Monday, July 11** This day dawned with a crispness to the air as a high pressure ridge had moved into Michigan and was expected over Rockton by mid-afternoon. And what a day it turned out to be with typical thermals of 3-3.5 knot thermals with best thermals of 5.5 reported. Once again Ulli Werneburg was the best of the 15m Class and this is how he saw the day:

"The morning had a pleasant, cool feel to it, a marked contrast to the previous hot, humid days. At the pilots meeting we were set an ambitious 375 kilometre folded quadrilateral (to Tillsonburg — Priceville — Woodstock and return) mostly in the centre of southwestern Ontario — the task committee having wisely kept the course as much as possible away from all the Great Lakes in the vicinity.

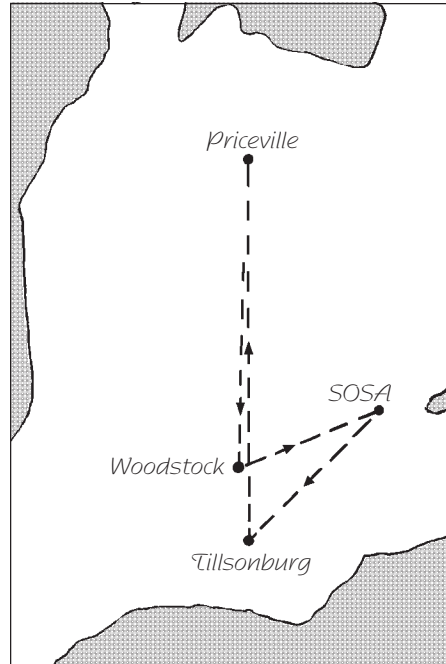

The cu formed on schedule and it was evident that it would be a good soaring day. Nonetheless, at first the thermals were weak, to about 3500 feet, and a shear in the surface winds was a problem if one got low. Because of the length of the task and possible complications from lake effect at the turnpoints, I wanted to start relatively early, but chose to wait until thermals improved. Finally I got a good one of about 3-4 knots to 4200 feet and started out at 1250. The run southwest to Tillsonburg was excellent with no complications and an average thermal strength of 3-4 knots with lots of nice cu, and I reached the turnpoint at 1344.

The next leg, the long run north to Priceville started a lot less positively. Blithely pushing on towards Woodstock I failed to notice a relatively dead area, and passing up indifferent lift, found myself at under 1800 with few good cumulus around. I and four other sufferers (DB, P1, S1, and LJ) finally managed to contact 2 knots and gratefully climbed out of the hole. I left at about 3000 feet since I noticed a nice cloud building up just east of course. It rewarded me with a 4-5 knot thermal to 4600 feet and I proceeded quickly on course.



The day required a good deal of zig-zagging around, using the so-so lift of many clouds simply as a means of maintaining height while flying straight. Occasionally I would stop to circle in 4-5 knot thermals, however these were difficult to locate under the fairly spread out cu. Near Elmira I shared a couple of thermals with EE. The flight proceeded uneventfully towards the north with small streets forming in a north-south direction. Unfortunately, the cumulus bases did not go up with the higher terrain but the lift was still good. Between Arthur and Mount Forest I met up briefly with DM. The next challenge was to find Priceville, a small village southwest of Flesherton. After locating a few clear landmarks (lakes) in its vicinity, I had no problem in finding it.

After the turnpoint I saw one glider going in and that was the last competitor I saw on the task. The return leg south to Woodstock was more into the wind, but the clouds were still lining up a little bit and the best lift was still in the 4-5 knot range, though fairly scarce. I was able to make good progress. I approached Woodstock from a northeasterly direction because of some good clouds in that direction.

I was now becoming concerned about the lack of gliders in the vicinity of the turnpoint. It is usually inevitable to see other competitors at turnpoints, but I hadn't seen anyone for what seemed ages. This led me to think of three possibilities: either I was on the wrong task, I was way behind or I was well ahead. I checked and re-checked the course and it was the correct one. So I just carried on, occasionally taking peeks behind and ahead of me, but seeing no one. Now I just needed one more decent climb and I was home. Unfortunately, it took its time coming and I bumbled around a bit to try and climb. Finally I had easy final glide height, especially with the tailwind.

Rockton turns out to be almost impossible to spot from anything more than five kilometres out, but the landmarks were all there and finally I spotted the field to my delight. It was empty of competitors and I finished at 1710, 4:20 hours after the start for just over 87 km/h. Because of my early start no one else finished until K2 came across at 1730. Then everyone else began to finish, giving evidence of an excellent soaring day."

Jörg Stieber won the day for the Standard Class at a speed of 78.4 km/h. Only two 15m and six Standard Class gliders failed to complete the task. For the pilots this was a great relief as it had taken seven days to get to a 1000 point day.

Relief was short-lived. The next day saw a cold front moving in from the north and local Cb activity was moving in from the west. The front slowed up and eventually became stationary just south of Lake Erie, and thus Tuesday was another scrub.

*Wednesday, July 13* The day dawned bright, clear and blue. Dave Springford (S1) in his dad's ASW-20 takes us through it:

"The day started out with the potential to be another boomer. The pilots meeting was set for 9 am and the task announced as a four hour POST. The launch time was to be 1200. At the pilots meeting, Bernie's weather briefing indicated that there should be cu popping around 1130 with bases in the afternoon upwards of 5000 feet agl. A "weatherless" cold front with unpredictable effects was also going to move into the contest area in the afternoon.

At noon as we all waited on the grid to launch there still wasn't a cu to be seen. A sniffer was sent up only to plummet back to earth. The towplane went off for another tephigram flight to see what was happening. In the meantime the task committee got together and set a secondary task of Rockton — Woodstock — Mount Forest — Guelph — Rockton (236 km) just in case it turned into a blue day.

Finally we launched around 1300. Initially everyone had trouble staying up. Water was falling from gliders everywhere. The task committee then had another change to the task — shortening it to Woodstock — Arthur (194 kilometres) as the day was now definitely not going to be a boomer, and a radio roll call was made. (Later Bernie told us that the temperature for the day peaked at 1330 then slowly declined and this killed the prospect for cu and decent lift.)

A few isolated small cu started to form around the field. Everyone raced to them only to find marginal lift. Both start gates were now open, but no one was in a position to start. Finally someone found a good thermal just south of the field. Observers on the ground counted 21 gliders in the gaggle. While everyone was in this gaggle, I had moved out on course about five kilometres to check for lift under another small cu. It turned out to have a couple of knots under it.

I had climbed about 1000 feet under the cloud when 77 joined me. We did a couple of more turns for a few hundred feet and then Jim Oke (77) headed west on course and called in his start time. Brave guy, I thought, as it was completely blue. I headed back towards the field and heard everyone in the gaggle starting to call in start times. This concerned me a bit as I knew it would be a gaggle type day and I didn't want to get left behind. I raced for the start line and got a start at about 2000 feet a couple of minutes after the gaggle had started.

The first leg to Woodstock was reasonable. There was lift up to about 2 knots with occasional shreds of cu forming briefly and there were three small gaggles progressing towards the turnpoint at slightly different rates. We ran most of the first leg between 1500 and 2500 feet.

As I flew in for the turnpoint I saw MZ coming up from the south and followed him around for the picture. As we turned, we flew through some lift and started to thermal. As I came around to the southeast I

saw a horde of gliders swarming towards the turnpoint and soon "the Gaggle" formed. (We didn't realize that this would become the lowest, slowest, biggest, longest running gaggle ever flown in Canadian contest history.) When I left it to dump the last of my water I found myself down to about 800 feet and thought that I was done for. Fortunately I managed to climb about 400 feet and then flew a kilometre to join 1M at the bottom of the gaggle.

As the gaggle moved north I stayed in the thermal to try and climb a little higher before leaving. DB and I left at about the same time and headed north. A few kilometres later we hit some good lift and stopped to climb. As we were climbing I could see the gaggle a few kilometres further north. They were quite low, and until Tony Burton in EE spotted a hawk they might have all landed.

The size of the gaggle was totally non-productive as survival dictated maintaining separation and shallow turns. Even though the small thermals had cores of 2 knots, no one could centre long and average climbs soon dropped to zero.

Eventually all the survivors moved north in the gaggle. There were about 16 gliders still left in the gaggle and this lasted for about 45 kilometres to Elmira as the gaggle moved north. Most of this leg was flown between 800 and 1800 agl. The farmers cutting hay got a great show as first one or two sailplanes would appear circling low overhead and then the whole flock would converge on them. Regularly the lowermost gliders would be scraped from the bottom of each thermal so the courseline of the gaggle was marked by gliders strung out along the fields.

As we reached St. Jacobs, a Mennonite community south of Elmira, there were only about eight of us left. Things were getting critical by this time as we were down to about 700 feet. Fortunately Jörg Stieber and I found some lift and once again climbed to about 2000 feet. As we spread out after this climb and headed for Elmira, I thought that I might get something off the factory in town. I got there and flew into some 3 knot lift. As I climbed over the town, I directed two of our American pilots into the Guelph gliding club strip west of town. I was really amazed that after a few turns the thermal hadn't quit and that the remnants of the gaggle hadn't appeared under me. Finally, as the thermal was dying, ST and K2 came in underneath me. By this time I was over 2000 feet and headed out on course.

From that point on it was pretty smooth. In the next 15 kilometres I managed to bump a few small thermals but ended up landing just north of Elora. In the end I had managed to fly 117 kilometres in three and a half hours. As I landed I thought that I might just have enough distance to place well on the day. When my crew arrived, they told me that I was the last pilot to call in and had gone the furthest. My crew had really enjoyed themselves back at the field whilst aggravating some of the other crews with



1994 Nationals Scores			6 July 126.2 O&R			9 July 3 hr PST			11 July 374.8 ■			13 July 194.1 ▲			Total points
			day pos	km/h	pts	day pos	km	km/h	pts	day pos	km/h	pts	day pos	km/h	
<b>15 METRE CLASS</b>															
1	Wilf Krueger	LS-6 K2	3 (62.3)	137	3	56.3	18.8	78	2	81.2	917	3 (106.4)	610	1742	
2	Colin Bantin	ASW-20 3B	3 (62.3)	137	2	95.3	31.8	189	8	72.5	794	4 (100.8)	578	1698	
3	Ulli Werneburg	ASW-20B MZ	1 (64.4)	142	1	99.2	33.1	200	1	87.0	1000	13 (59.6)	342	1684	
4	Dave Springford	ASW-20 S1	3 (62.3)	137	10	22.4	0.0	27	6	73.5	808	1 (117.2)	672	1644	
5	Nick Bonnière	ASW-20 ST	3 (62.3)	137	7	42.6	0.0	51	5	74.1	816	2 (110.8)	636	1640	
6	Walter Weir	ASW-20B 2W	10 (44.2)	97	5	43.0	0.0	52	4	76.6	852	8 (92.8)	532	1533	
7	Heri Pölzl	LS-6 KC	1 (64.4)	142	9	26.2	0.0	31	9	71.6	781	4 (100.8)	578	1532	
8	Jim Oke	ASW-20 77	13 dnc	0	4	61.0	0.0	73	3	80.6	909	9 (92.6)	531	1513	
9	André Pepin	DG-600 DB	8 (51.5)	113	5	43.6	0.0	52	7	73.3	805	10 (92.5)	530	1500	
10	Lorry Charchian	LS-6 LJ	7 (52.6)	116	12	0.0	0.0	0	10	69.9	757	4 (100.8)	578	1451	
11	Tony Burton	RS-15 EE	10 (44.2)	97	12	0.0	0.0	0	11	65.1	688	7 (99.3)	569	1354	
12	Ed Hollestelle, Jr	HP-18 57	12 (37.7)	83	11	20.4	0.0	24	12	60.4	621	11 (68.2)	391	1119	
13	Alan Wood	1-35 AO	9 (50.7)	112	7	42.4	0.0	51	13 (353.4)	359	11 (68.1)	391	913		
14	Tom Coulson	Mosquito W2	13 (0.0)	0	12	0.0	0.0	0	14 (100.4)	102	14 (0.0)	0	102		
<b>STANDARD CLASS</b>															
1	Jörg Stieber	LS-4 JS	1 (64.4)	86					1	78.4	1000	2 (100.8)	521	1607	
2	Ray Galloway	ASW-24 P1	3 (52.5)	70					3	73.4	938	2 (100.8)	521	1529	
3	Ian Spence	ASW-24 WW	6 (45.1)	61					4	69.6	891	1 (103.5)	535	1487	
4	Ed Hollestelle, Sr	SZD-55 XT	7 (45.0)	60	Not a contest day				2	73.5	939	4 (93.9)	485	1484	
5	Paul Thompson	LS-4 T2	4 (50.7)	68	for Standard as only				5	(68.5)	878	6 (81.8)	423	1369	
6	Kerry Kirby	Jantar 2 69	8 (36.9)	49	two pilots exceeded				6 (331.2)	455	4 (93.9)	485	989		
7	Fred Hunkeler	Jantar 2 1M	9 (27.3)	37					7 (323.9)	445	7 (68.2)	352	834		
8	Janicek/Gower	Hornet DW	4 (50.7)	68	50 km (3 req'd).				10 (271.3)	323p	8 (64.4)	306p	697		
9	Dave MacKenzie	SZD-55 DM	2 (54.2)	73					8 (291.5)	401	11 (35.6)	184	658		
10	Richard Longhurst	SZD-55 4Q	11 dnc	0					9 (271.3)	373	9 (39.2)	203	576		
11	Dugald Stewart	Cirrus 75 HG	10 (25.8)	35					11 (182.8)	251	10 (36.7)	190	476		

( ) values in brackets are distances if pilot landed out on an assigned task.  
"p" denotes the application of a penalty reducing the earned daily points.

their cheers every time the phone rang and it wasn't me. But it was all in good natured fun and the spirit of competition.

All in all it was an exciting flight. We flew in the mother of all gaggles for over 40 kilometres and through good luck or good management we are all here to tell the stories today."

Jörg Stieber had once gain completed the greatest distance in the Standard Class covering 100.8 kilometres and receiving 521 points for his efforts. Dave Springford received 672 points for his efforts in the 15m Class. Unfortunately for Ulli Werneburg it was his contest to lose. Ahead by over 200 points at the start of the day, he left the big gaggle shortly after it formed and soon landed out, and Wilf Krueger took overall lead in the 15m Class by 44 points.

The success of the day's flights (although once again 100% of the field had landed out) guaranteed the 15m Class a contest as they had now completed four task days. Things were becoming critical for Standard however. With three task days completed and only one day left, it would be a do or die day for the class.

#### THE TROPHY WINNERS ARE:

**MSC Trophy** – 15m Class champion  
1742 of a possible 2014

**Wilf Krueger (K2)**

**Mix Trophy** – Standard Class champion  
not awarded

**Dow Trophy** (best assigned task flown)

*15m Class* – 375 km at 87.0 km/h  
**Ulli Werneburg (MZ)**

*Standard Class* - 375 km at 78.4 km/h  
**Jörg Stieber (JS)**

**Carling O'Keefe Trophy** – best team  
**Stan Janicek/ Charles Gower (DW)**

Thursday dawned with an overrunning stratus level that reduced surface heating to such an extent that the tephigram showed thermals would reach less than 1300 feet and would have a strength of less than half a knot. Thus with great regret, Larry cancelled the final day as there would have

been no chance for any competitor to achieve scratch distance and give the Standard Class their fourth day.

So as it started, the 1994 Nationals had ended with a non-flying day. This was being called the land-out Nationals (75% plus another 8% who landed back at SOSA with no distance), but for the competitors the one great day on Monday had given at least some good feeling to the contest (it was the third longest distance completed for an assigned task — there was a 387 km triangle in Swift Current last year and a 377 km triangle in Virden in '84). It also marked the first time in 24 years that a no-contest had occurred (the failed 1970 contest in Carman didn't have a division of classes at that time). Our American competitors (some of whom Walter Weir had enticed north after flying with them in the Seniors competition in Florida) enjoyed themselves and the friendly spirit of our Nationals. All promised to do it again at Pendleton next year.

Congratulations to Wilfried Krueger for winning the 15m Class, and our commiseration to Jörg and the other top placed Standard pilots for not having the opportunity to earn the Wolf Mix trophy this year.

# Test Driving '54'



Jay Poscente

## Gerald Ince

Cu Nim Gliding Club

SEPTEMBER 5, 1993 — I sit on the flight line in new and unfamiliar surroundings — the cockpit of Mini-Nimbus "54". Having purchased a half interest in the Mini from Jay Poscente earlier in the week, I am about to embark on my first flight as a private owner. As a pilot I have cut my teeth on Blaniks, the Jantar 2 and a Grob 103. This will be my first flight in a 15 metre flapped ship. I am confident about every aspect of the flight except for one: the parts attached to the business end of the flap handle resting beside my left thigh. I have been practising on the ground — flaps from negative to positive during rollout; from positive to negative after flare and touch-down, but the control movements seem foreign to my hand. After a final briefing from Jay I complete my cockpit checks for the tenth time. Bruce Hea comes over to offer a few words of advice. At the time I don't realize how important his words are. "Keep the wings absolutely level when landing. These high performance ships will ground-loop if you come in with one wing low."

As the towplane inches forward to take up slack I make a mental note of encouragement to myself. This takeoff will be exactly like each of the 175 previous takeoffs I have logged with one small exception. Once aileron control is established I will move that lever back a couple of notches. Jay takes a final look at me before signalling all out to the towplane. As the Mini gains airspeed I gently pull on the flap handle and lock it in position. I have, of course, waited a few seconds too long. The Mini balloons up 15 feet above the runway as the airflow is deflected downwards by the now positive flaps. I sense an uncomfortable sloppiness in the controls as if the Mini is trying

to tell me "We're not going fast enough for this." Moving the stick forward a little too far, a little too late, results in a gentle touch and go. "Don't overcontrol, don't overcontrol," I chide myself out loud. Nevertheless, as we climb out the Mini oscillates up and down behind the towplane like a fishing lure. I realize that I'm going to have to work on my aerotows again. This is no Blanik.

Cloudbase is about 7000 feet asl (3000 agl) and the Scout has to make some gentle turns between them on our way to 8000 feet. There are soft, medium sized cumulus clouds all about and the view is quite spectacular as we climb beside and finally above them. My goals for this flight are simple:

- get comfortable with the handling characteristics of the Mini,
- investigate the low speed flight behaviour, and
- get used to the landing attitude by experimenting with the flaps and spoilers.

At 8000 feet I punch off and trim the aircraft for 50 knots. I am pleased to find the handling is very docile. The controls coordinate beautifully and the roll rate is much better than anything I have flown previously. I am immediately impressed by the "slipperiness" of the aircraft — push the nose down and the aircraft accelerates quickly; pull back and the airspeed gained is quickly reconverted into altitude. Like Crisco oil, the altitude all comes back, except for one tablespoon!

Grinning from ear to ear, I am too happy for my own good. I'm a private owner! My days of patiently waiting for a flight in a club ship while perfectly formed cu float by overhead are behind me! No more one hour time limit! I decide to have some fun with

the Mini. I have noticed a few bumps of lift under these rather soft looking cu. Raising the gear and pulling the flaps full on, I bank 54 over into an effortless climb to cloudbase. I venture a little away from the field to try my luck under a nearby cloud. With nicely spaced cu and only a light breeze from the east, the consistent two knot thermal I find under each cloud affords an opportunity to dolphin fly. I travel straight ahead for several kilometres, speeding up in sink and slowing down in lift, reaching cloudbase again each time. About 8 kilometres west of the Black Diamond airfield I find a four knot thermal in the blue. I radio back to Jay, who is on the ground, and let him know how impressed I am with the Mini's performance. "I'm going to see if I can stay up for a little while as the day seems to be improving."

Dolphin flying under the popcorn cu takes me to Quirk Creek gas plant (22 kilometres due west of the Black Diamond airstrip) in short order. I centre a one knot thermal directly over the plant while I play tourist and watch the activity below. I spend a few minutes fiddling with the ILEC computer mounted in the instrument panel. Although I have maintained altitude as I ventured west into the foothills, the ground has been rising up to meet me. My thermal eventually dissipates and I spend the next several minutes rowing around trying to find something else which is working.

With my hands and mind preoccupied with all the toys inside the cockpit of the Mini, I have not noticed that the sky around me has taken a turn for the worse. I now find myself in the middle of a blue hole that stretches for several kilometres in each direction. Although the September sun is still shining the local thermals have chosen to

cycle all at once. I use up the better part of thousand feet trying to reconnect with something kicking off the nearby ridges before beginning to head for home at about 1500 feet agl.

Flying east and into wind I realize that I am in trouble. The ground below me is rugged terrain; trees and rocks leave few fields suitable for a landing. Running home requires crossing a number of low ridges which threaten to cut me off from the airfield. I know that in the past I have always been able to find lift in this area. What if there is none today? The vario has gone mute, and I can only coast along at best L/D. I make an 'S' turn here and there whenever I feel a bump, but these efforts are mostly wasted.

By the time I travel seven kilometres back along my original route I am down to circuit height. Below me on either side of a gravel road are the best looking fields I have seen in some time. Although sloping up from east to west they are relatively smooth and have been under cultivation. I see a pickup pull into the driveway of a nearby farmhouse. Do I put the Mini down here, risking damage to the aircraft by landing out on my first flight? Should I continue on, hoping for a low save which will spare me the embarrassment of having to call my new partner for a retrieve? Finding a bubble of lift, I crank the Mini into a turn in the hopes of buying a minute or two in which to make a decision.

Given my current height, I decide that the odds of a low save are rather long. Looking downhill to the east, I don't see any potential landing sites that look as good as the fields below me. Continuing on may be a one way ticket; level ground is a scarce commodity below. My decision is effectively made. I try a radio call to Black Diamond to inform Jay of my intentions but there is no response. Focusing my attention fully on the landing, I take a good look at the fields below me. My heart sinks as I see the surface swaying gently. There is an uncut crop standing in both fields. The wet weather we have been experiencing has precluded the farmer from getting his equipment into the field to cut his hay. I look around again but the alternatives are not attractive. In the field to the right of the road I can see dark patches. Assuming these to be wet spots, I decide to land on the field to the left. Landing into wind is not an option as this would require me to clear a stand of trees before landing downhill. My first landing on type will be downwind into a four foot high crop!

The adrenaline has kicked in by now. Although I am concentrating on planning out my circuit I cannot completely block out a sense of dread lurking in the back of my mind. I have not surrendered to fate; I am still flying to the best of my ability. I am not afraid for my personal safety; the possibility that I could be injured does not enter my mind until later. Yet there is a heaviness in my chest, a heaviness caused by the growing realization that as a pilot I have made a serious mistake. "I can't believe this is hap-

pening" I think to myself. Decisions made minutes before, or in this case, decisions not made, have set into motion a chain of events that I can now only partially control. Like a chess player, I cannot take back a bad move made previously. Having lost my Queen, I now fight on hoping only to secure a draw.

Improvising an abbreviated circuit, I decide to overfly the centre of the "runway" to take a final look for hidden obstacles. I quickly complete my SWAFTS check and concentrate on maintaining my airspeed for the final two turns. As 54 turns final I open the spoilers wide to bring the Mini down to ground level quickly. "Keep the wings level, don't let the speed increase!" Approaching the ground, I gently ease the spoilers closed, but not locked. The Mini skims along in ground effect. At times like this an L/D ratio of 39:1 is a distinct disadvantage! My approach is made uphill and I have to keep steady back pressure on the stick to maintain my height above the rising ground.

Before long I hear the first stalks of the tall crop tickling the bottom of the Mini's fuselage. I continue to maintain this attitude, trying to bleed off all excess energy for several hundred feet. Although I have picked a rather large field, I can see the driveway and barbed wire fence at the far end becoming ever larger. The crop is now sweeping the bottom of the fuselage and a few wayward seeds start to fly into the cockpit. My concern about the fence at the far end is growing rapidly. Just about the time I decide that I can't continue on with the spoilers shut, the Mini runs out of energy and settles into the hay.

WHOOOMP! When the crop finally grabs hold of the Mini's wings she stops like a fly caught in a spider's web. My body rebounds off the shoulder straps, and suddenly all is silent. "That wasn't too bad," I think to myself. Given the chance of a ground loop, or even a cartwheel, I have been incredibly lucky. The tail of the Mini rests only two or three feet off the centreline of my approach.

I should be filled with a sense of relief. I have done something stupid and got away with it. Instead I am overcome by anger. I am angry at myself for making the mistakes that have brought me here. I tell myself I am a better pilot than this. Yet here I am, snagged in a crop as tall as my aircraft. I sit motionless in the cockpit for a minute pondering my own foolishness.

My bout of self pity is interrupted by the sight of a teenage girl, still in her Sunday best, running towards me through the crop. As she gets closer and closer to my downed craft her run turns to a walk. About thirty feet away, she stops. Standing on her toes, I watch her peer left and right above the tall grass. I can clearly see the fear all over her face. She is looking for signs of movement before venturing any closer, afraid that she may find herself alone with an injured pilot. Gathering my own composure, I open the canopy and shout to her that I am fine,

this type of thing happens all the time, etc. Her parents arrive moments later in a cloud of dust as their pickup screeches to a halt on the nearby road. "Would you mind if I borrow your telephone," I ask them sheepishly after introducing myself....

Writing an article about this flight has been somewhat cathartic for me. Nobody likes to admit to their mistakes in public. Nevertheless, I write on in the hope that there is something contained within from which other "low time" cross-country pilots can benefit. Here are some of the things that I took away from the experience:

- On making your first few flights on type, set an objective for the flight and then stick to it. No matter how good the day looks, don't modify the plan or go on a cross-country. In this case, over-exuberance is a character flaw.

- Moving to a higher performance ship can be a double-edged sword. These ships open up a whole new range of possibilities in terms of how far and how fast you can fly, but they also allow you to get yourself much deeper into trouble. As a low time cross-country pilot I should have never ventured into rough terrain while relying on two knot thermals.

- When flying over inhospitable terrain, there is no time to play tourist or fiddle with your camera or instruments. You must be analyzing your options all the time. When the number of available options start to dwindle, get out of there. I should have noticed the change in weather and I should have seen the crop in my field much sooner.

- Never, never, ever land in a tall crop (unless the only alternatives are even less attractive).

- If you must land in a crop, keep the wings level and put the aircraft down with absolute minimum energy. Spoilers should be closed, especially if they extend below the wing surface where they are likely to catch and cause a ground loop. I landed with flaps extended because on the Mini they dramatically lower the stall speed (to 32 knots). You may want to consider your individual aircraft if you find yourself in a similar situation.

- No matter how bad things look, you *have* to keep making decisions and flying the aircraft. There is no point in wasting mental energy beating yourself up over what could have been or should have been. Once you are committed to a course of action you must execute. Simplify things for yourself. Concentrate on those critical tasks that you have to perform in the next minute (coordinate turns, wings level, minimum energy touchdown). Never give up. Your job isn't done until the airplane is back in the trailer.

- It pays to pick a good partner! Many thanks to Jay Poscente for being so understanding, and to Karin Michel, who helped on the retrieve.



# medical facts

## THE SIDE EFFECTS OF ASPARTAME IN DIET DRINKS

from *Canadian General Aviation News*

RECENTLY a letter was sent to COPA (the Canadian Owners and Pilots Association) in which a pilot expressed his concerns over questionable adverse effects from consumption of diet drinks containing aspartame. By 1986, the FDA and the Centre for Disease Control in the USA had evaluated 3000 known complaints. Fellow pilots who may have had similar side effects may be interested in the information below.

*Plane and Pilot* magazine featured an article on drugs and alcohol vis-à-vis safe flying practises that also talked about food additives. It explained that diet soft drinks are sweetened artificially by "aspartame" (with brand names NutraSweet and Equal), and that aspartame contains 10 per cent methanol. That caught my attention! I know that methanol (sometimes called wood alcohol) is a poisonous substance, which on ingestion causes blindness and death; two teaspoons full are considered lethal.

The article disclosed that methanol destroys the brain, albeit a little at a time, and that effects are cumulative. Depending on a person's physical state and tolerance level, immediate effects can either be severe (resulting in epileptic seizures, including grand mal, blindness, chest palpitations), or less noticeable (causing blurred vision, "bright flashes", tunnel vision, ringing or buzzing in ears, migraine headaches, dizziness, loss of equilibrium, lip and mouth reactions). Less noticeable effects might be passed off as temporary or caused by something else. But everyone is affected in one way or another, since methanol causes toxic reactions, not just allergic ones, in a few unfortunates.

Here are direct excerpts from the article:

"An Air Force pilot traced the patterns of tremors and seizures he suffered for two years directly to his patterns of NutraSweet consumption. When he travelled to areas where diet sodas were not available, he was free of the symptoms. But when he resumed intake of the beverages, his tremors resumed, grew more severe and culminated in a grand mal seizure that ended his flying career. His medical problems ceased when he quit ingesting NutraSweet, but it was too late to restore his flying status."

"Another pilot suffered similar symptoms only when using aspartame products. But FAA revoked his medical certificate when it was informed of the symptoms. After only two cups of artificially sweetened hot chocolate, a pilot experienced blurred vision so severe he was unable, in flight, to read the

instruments and very narrowly avoided a tragic landing. Safely on the ground, he related his symptoms to the secretaries in his office. Both of them told of experiencing similar symptoms after ingesting aspartame products."

I, too, had bad experiences with aspartame. It replaced saccharin about 10 years ago; as a marathon runner in my 30s I consumed litres of diet drinks daily at that time. When I first drank pop with aspartame, it had immediate and severe effects upon my consciousness and vision. After a few scary incidents, pop consumption and problems seemed related.

I described symptoms and circumstances to my doctor. He ran tests, but never seriously listened to my concern of relating pop with the effects. He was a reasonably competent GP, but not ready to distrust, let alone blame, an FDA approved sweetener. Eventually I quit ingesting aspartame and have not had incidents since. Employed in the professions and a post-graduate, I conduct research occasionally and am aware of the difficulty of matching cause and effect (and the danger of doing it improperly). But there is no doubt in my mind that "tests" with my body proved that aspartame is bad (at least for me).

Apparently the other main components of aspartame, phenylalanine (50 per cent) and aspartic acid (40 per cent), combined with the methanol (10 per cent), create a witches brew of 16 breakdown products after digestion that cause illness. Animal tests revealed brain tumours, some cancerous; holes in the brain, womb tumours, uterine tumours, and reproductive dysfunctions. Studies on humans indicated that pregnant women and young children run especially high risks.

If pilots want more information, I encourage them to call The Aspartame Consumer Safety Network in Dallas, Mary Nash Stoddard, (214) 352-4268. ACSN promises confidentiality if asked, and will send an eye-opening information package.

*Comment by Dr. Peter Perry  
Chairman, SAC Medical Committee*

*This is an interesting article on aspartame and methanol and their side effects, all of which are quite valid. I am sure the aim of the article was to increase pilot awareness of the same. However, I think it has been taken out of context, so to speak, and we have to put the information in the proper perspective. The writer of the article and, I am sure, the other people he has spoken to did indeed have those alarming symptoms, so other users of aspartame should be aware of that possibility, particularly pilots.*

*If one looked at the full range of side effects of Aspirin and Tylenol, to take two other over-the-counter drugs as an example, one probably wouldn't dream of taking them because they can both produce a wide range of serious side effects, some of which can even be fatal. Even regular coffee is not to be taken lightly — I have seen one authority write that the consumer would be unfit to drive a car after two cups.*

*Aspartame and the other drugs mentioned have been around for quite some time. They have nasty side effect profiles. But millions of "doses" have been taken. So what is the bottom line. The important thing to consider is not the possibility but the probability of an adverse reaction occurring (bad side effects have low probabilities). Luckily, all the specific cases referred to in the article had dramatic side effects with rapid onset, making it easy to recognize and so respond appropriately. Often we are at more risk from medications with insidious onset of reactions, such as cold remedies and sedating antihistamines, to say nothing of alcohol, smoking, and hypoxia.*

## WINGS & WHEELS

GPS Systems  
IIMorrow, Becker, Garmin,  
Magellan, Trimble

Radios  
Communications Specialists,  
Becker, Terra, Icom

Variometers  
Soaring Aids, Ball, Winter, Sage

Parachutes: National, Strong

O2 systems: Nelson, Aerox

Barographs: Replogle

Seatbelts, new and rewinding service  
German & American mylar seals and tapes  
Batteries, chargers, crew car antennas,  
wingstands,

Glider canopies, windshields/windows  
for most A/C: LP AeroPlastics

and much more!

*Absolutely the best prices and service.*

New and used equipment  
bought, sold, and traded.

Call Tim Mara "1M"  
(716) 664-6894, fax 664-6895

— send \$2.00 for catalog —  
81 Jackson Avenue WE,  
Jamestown, NY 14701



Finally, why wasn't this change put forward as a proposal in *free flight* so that the ordinary member, and the ordinary instructor, could have a chance to suggest improvements before it was enacted?

Jack Dodds, Erin Soaring

Ian Oldaker responds:

Jack's letter raises some interesting points. First, I believe we went about suggesting changes to this badge in a responsible and thorough way. It was after discussions with our president and directors in late 1992 and 1993 that the idea to amend the badge first surfaced. The first proposal was then made at the CFI's seminar (in 1993), and was followed by discussion at two Association AGMs and discussions with the Advanced Soaring Association as well as within our own Flight Training & Safety committee who are now sponsoring the Bronze badge. We received some comments from these and other people, and overall enthusiastic support, which seemed to me to say, "go for it!" I am sorry Jack did not see the proposed changes earlier, but trust the following will satisfactorily explain what we did.

The badge is seen as providing all pilots with realistic soaring-related goals that they will be able to achieve quite easily in their early solo flying, and that they are not such a large step as the Silver C badge with its five hour flight requirement. The fact that some of the Bronze badge goals can only be achieved by getting additional instruction means that the more experienced instructors will be asked to become involved too. This is not such a bad idea, as those who no longer like sitting in the back teaching ab-initios will be able to do some soaring instruction instead, and pass on the skills they have developed over the years to the next wave of pilots.

During our discussions a problem was brought up — pilots entering cross-country clinics have had large differences in experience and skills, making the courses difficult to run. Therefore it became apparent that we needed to establish a "standard" entry level for these clinics. So the Bronze badge will become the basic entry level for cross-country clinics run by our two associations. From this, some suitable tasks were devised. If a club wishes to use this badge as the basis for the cross-country checkoff, so much the better; and we will have a national standard that all CFIs can follow. The skills will apply equally to pilots who do not wish to fly cross-country, but who wish to become better all-round soaring pilots.

The encouragement is supposed to be to the early solo pilots, and therefore we have tried to minimize the paperwork. Signatures or sign-offs would be collected over several weeks while the different tasks are completed. Come on Jack, one of the aspects of soaring badges is the paperwork, so an early

introduction to it is useful, in fact the red tape here is only one small checklist! Compare that to the Silver C application.

I and several of my associates believe this sort of activity *will materially improve our retention of pilots who have just started the sport*, and who see that the challenges are continuing after solo and licensing, with exciting flying including some work with senior instructors. We need to continue our involvement with our newer members after licensing, and this is considered to be one way of doing this. Let's go for it!

Jack has quite rightly said that approaching over the threshold at 1 metre is dangerous, however in this case the 150 metre marked-part of the runway is supposed to be *within the normal runway* so that the pilots will cross the airfield boundary at the normal heights that they are used to. In other words a pilot will still approach normally and will have an aiming point well within the normal runway length; the 150 metre marked area may include or it may be beyond the aiming point. In either case the pilot is to cross the threshold of the marked area at the 1 metre minimum height specified. This should ensure that low time pilots will not develop a habit of aiming at the very end of their normal runway, but will be well within it. I trust other pilots did not assume that we meant the 150 metre length should start at the threshold or field boundary!

Upon reflection, what is the "threshold"? It is not necessarily the very end of the runway, but some mark down it. San Diego's main runway (facing the ocean) has its landing threshold perhaps 3000 feet into the runway, because the nearby mountain dictates such an approach.

The gliders that most of us fly as a first solo machine (eg. 2-33, K-13, 1-26, etc) should be stoppable in the required 150 metres *if the landing is properly held off*. If pilots flying a higher performance glider wish to try this exercise without a wheel brake, perhaps they should try the landings in a 2-33 or 1-26!

### SEARCHING FOR DIAMANTS

We are attempting to find the current owners of "Diamant" sailplanes. There were eighty-three ships originally produced in Switzerland from 1964 to 1971. Almost half of these sailplanes were imported into the USA and Canada. We have had an active owners network for almost 20 years. Now we want to contact the other owners scattered around the world.

On 4 September 94, the Diamant original designers Thomas Bircher and Jurg Von Voornveld, together with René Come, chief construction sponsor and Marketing Director, will be celebrating the 30th anniversary of the first flight of the prototype Diamant. This type became the first factory production model and pioneered foam/fibreglass composite sandwich construction (through-

out the entire fuselage) as the world's first certified flight structure of this material.

The celebration will be at Skylark North Gliderport in Tehachapi, California. All Diamant owners, past and present, are invited to be there. If a sailplane is no longer flyable we would like to know who the last owner was and what became of the sailplane.

For further info or to correspond with the "Diamant Owners network" please contact:

Dan Pierson

1480 W. Compton Blvd, Compton, CA 90220

### ACCEPTABLE CONTROL LOCKS

(In reference to Dave McAsey's letter in the last issue) I was glad to see that some action is actually taken to secure that flopping Blanik elevator. However as predicted, I did expect to read some "flak" about the rubber bungy method of doing it. As I said, on my home field, I got "What's wrong with the belt?" From Cu Nim, at least David explains his objection and recommends control locks. From my point of view, whatever works for you, do it.

For control locks, I have seen some that might as well have been made of reinforced concrete, but who would want to carry them to the far end of the field when they are most needed? It is just too easy to forget and revert back to the belt. The belt method is not so bad, provided it is used properly. It is still easy to forget to fasten that stick after an exhilarating flight: "Well, we just push the plane a couple of feet anyway, what harm can come?" On a 1-26, a gopher mound can do the damage.

I have not read that article in SOARING about bent torque tubes. The Blanik uses torque tubes for the flaps, and push rods for the ailerons. Come to think of it, if one uses control locks for the elevator, one should also carry aileron locks, as the wind can sure bounce those barn doors around and bash the daylight out of the stops. Then we should also carry a rudder lock too.

If you have the manpower, the time and all five locks are handy to carry, by all means do it. If you don't, use at least the belts to fasten that stick. It can serve for both the elevator and the rudder. The rear seat belts can be used to keep the rudder from banging around by fastening to one of the pedals. If the wind is not a factor, one shoulder harness slid over the end of the stick and not tightened fully should suffice. But this is easy to forget. I know — I forget it often, even after hundreds of landings. On the other hand, the rubber bungy has only one purpose: to hold the stick off the stops during ground handling and keep the elevator trailing edge high. It is also a psychological tool to make certain it is used.

Regardless of what is used, use something that makes sense.

George Eckschmiedt

# VITAL ACTION CHECKS

are just that – vital

Suggestions for making them more foolproof

**Ian Oldaker**

Chairman, Flight Training & Safety

**A**N OLD PILOT who had not flown for many years climbed into the glider. I saw a look of pleasure come over his face, but then a small frown appeared. He didn't see the "usual" array of instruments. You see, he had flown a plane last during WW II, and his had been a four engined machine. His frown didn't last long however, and I got in to prepare for takeoff. I started the pre-takeoff checks and he said that he used to do those too, but they were much more elaborate. Then I could detect another frown as he said he couldn't easily remember his list. I told him this didn't matter as two of our gliding checklists were posted as convenient stick-on labels on the front panel. That seemed to satisfy him.

The point here is that checklists are as old as flying: if they were not needed they would not have been invented!

I wish it were always as simple as going through a list and checking the various items. However, there are some important points that need emphasis, especially as we continue to suffer misfortunes when pilots either don't do one of the checks properly, miss an item or don't do the complete list at all. This is examined below as many of our accidents are unfortunately attributable to the pilots not correctly doing their vital action checks.

Takeoff checks are important for several reasons. A good reason can be given for each item on the list. For example, if the controls are not checked for full and free movement, how can the pilot "guarantee" they will be free when needed? Full deflection is suddenly called for during the flight when a spin entry demands quick action ... it's too late now to remove that offending rudder lock. It has happened. Wow, you say, how could it? But it did.

We often hear about the "positive" control check. What is this, you may ask? After rigging the glider, can you *guarantee* that all controls are connected properly? Would not a firm check, with someone holding each aileron, then the elevator against your stick force, be a good insurance? This is the positive way we should check the ship after putting it together – every time. Did you do yours last time you rigged? Be honest, I know you feel they were done right, but think a minute of the pilots who have taken

off with one aileron disconnected. Yes, it has happened to two personal friends both of whom had the presence of mind to release before becoming airborne. Then there are those not so lucky, who crashed as a result of mis-rigging. Yes, it has happened – positive control checks are vital.

During the pre-takeoff checks a most important item to check is the spoilers, or dive brakes as they are often called for the more powerful types. How do you check them, and what do you check? First and foremost is the need to have them closed and "LOCKED". But first, they are often open during the first part of the preparations for takeoff, or they may appear closed but are not locked. Then there are the worn lock detents or catches of some gliders that will allow the brakes to open surreptitiously on takeoff. So what do you do? Make a point of saying out loud, "closed and locked" as you do this item.

Remember that an over-centre lock may be quite stiff and will require a fair force to push the handle over centre. Now, instructors please note: instruct your students to place the back of their left hand against the spoiler handle, (the back of the hand is to prevent the student inadvertently grabbing and opening the spoilers). Then as the take-

off starts, the pilots must monitor that the handle does not become unlocked and allow the spoilers to begin opening. By placing the hand in this way all pilots, of whatever experience, will be saved the trauma of landing in the trees or even landing in the river, or of hitting the ground hard following an interrupted launch. Yes, all the above continue to happen, for a painful and expensive experience.

Consider the poor tug pilot struggling with a very low climb rate at perhaps a slow speed, and wondering how to signal the glider pilot to check the dive brakes closed. It is a rudder waggle. Yes, this is the emergency signal to CLOSE THE DIVE BRAKES. Instructors – remind students of this, and perhaps show your students the

difference between the wing rocking – RELEASE IMMEDIATELY – and the rudder waggle – CLOSE THE DIVE BRAKES. This can be arranged with the tug pilot before takeoff, and will be a useful reminder to him too! To avoid having to do this at all, let's all start to consciously monitor the spoiler handle and to plan ahead for that interrupted launch.

One sometimes hears of low level launch problems such as a tug running out of fuel or a slow winch launch which demands a higher speed. In either case the only resort the glider pilot has is to release. What next?

*Checklists are as old as flying: if they were not needed they would not have been invented!*

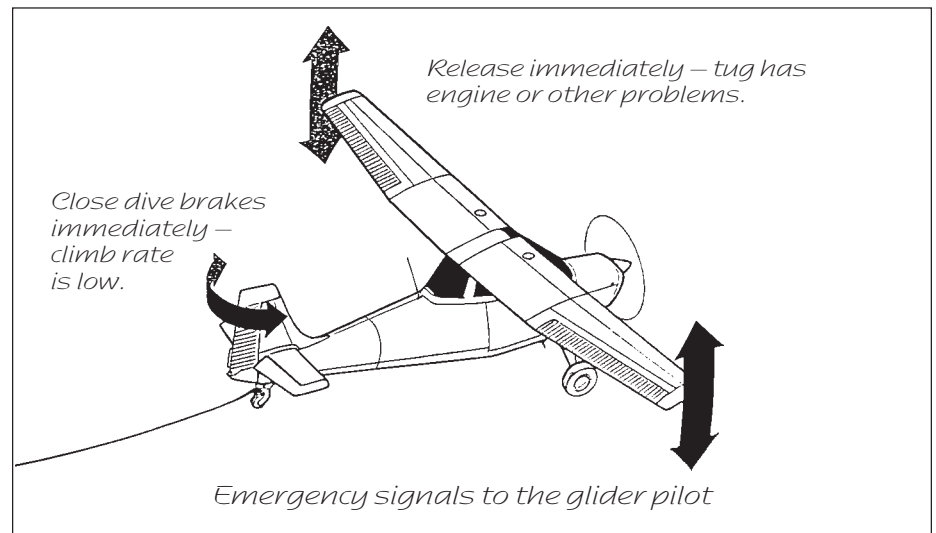

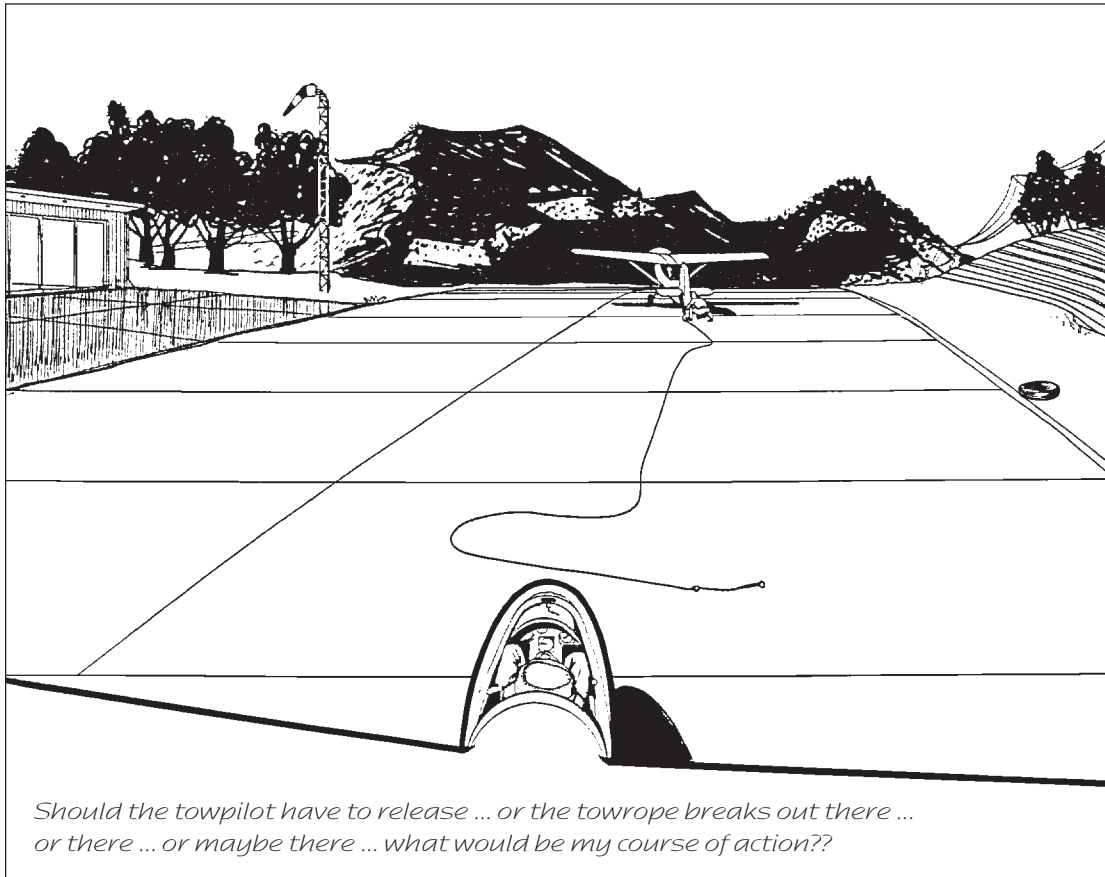

should note is to teach your students to LOOK AT THE SPOILERS as the handle is operated to check them on downwind (see page 28 of "SOAR and Learn to Fly Gliders"). If it is the wrong handle, such as the Blanik's or IS-28's flaps, this will become obvious immediately! These ideas should effectively eliminate use of the wrong handle, or raising the wheel for example, when doing pre-landing checks. The vital action checklists are just that — vital actions which if neglected can lead to trouble.

There are some extra things to remember about doing these checks. First and foremost is that when a pilot is preparing for takeoff, don't distract him or her — interruptions from you should wait. If you as the pilot are interrupted, start again right from the start of the list. In this way you will be assured that all items on the list will have been covered.

Too late to ask now, what to do should already have been in mind! In other words, plan ahead. Here again, instructors please note. Teach your students to anticipate the problem before it happens; this can and should include an assessment of the wind speed, where to land if a problem occurs "here" and "at this height", and what to do if the winch just does not pick up speed, remembering that we have now discontinued use of the too-slow signal on winching as being dangerous (see "SOAR and Learn to Fly Gliders" page 104). In this way the habit is formed in the new student's flying practises so when a real emergency occurs on a later flight, that day's plan can immediately be put into effect.

Sounds simple, but how many of us consciously do this? Low level launch interruptions (which is what they really are) can be handled easily by pilots who think ahead. This leads me to suggest we might add an item to the CISTRS-C checklist to read CISTRS-CO, the "O" being Options. What options do I have for an interrupted launch at various heights low down, for example? And because the wind is from one side and is fairly strong, this means I should plan my approach accordingly (depending on the runway layouts, available height, speed and so on). Plan what to do before takeoff, it may save embarrassment later.

Canopies have seemed to have had minds of their own in past seasons as several came open on takeoff. I trust pilots are deliberately checking that they cannot open the canopy by pushing up on the frame, after

they have "CLOSED AND LOCKED" it as part of the pre-takeoff checks.

Now we come to the pre-landing checks. Who would think that a pilot would forget his landing gear is down? But some guys have raised the wheel as part of the check, because the wheel had not been raised as part of a post-release check. Post release check, you say? Yes, don't you check rope/cable gone, re-trim, wheel up, location of club field? I do. Then there are the spoilers and flaps on some gliders such as the IS-28B2 Lark and Blanik which can and do get pilots confused. How are these problems overcome? It's been proven time and again that colour coding, shape of handle and even position don't prevent inadvertent use of the wrong handle, particularly when the pilot is under added stress. However it has happened, and pilots have overflowed runways because they had the flap lever in the hand and not the divebrake lever. And someone once pulled the 1-26 release handle for all they were worth but the glider still would not steepen its approach!

A simple routine that is taught in Australia is to follow the concept to "LOCATE, then IDENTIFY, and then OPERATE" the required control. For all ancillary controls, including those mentioned immediately above, this means to look at the handle, identify that it is the correct one and that it is in the expected position (wheel up or down; is it the release, spoiler or flap handle?), then to operate it. This substantially reduces the chance that the wrong control will be operated. An additional item that instructors

I haven't yet mentioned the other check, CALL, the check to do before doing stalls, spins or aerobatics. It is equally important to go through this one of course; instructors should note when a student forgets that it is far better to stop them right away and to go back and do the checks properly before doing the maneuver. Don't let the student persist in doing a stall and then correct the fault! Doing something incorrectly is allowing them to learn it that way. And if you, the innocent bystander, should notice a pilot not going through a pre-takeoff check, how about doing the pilot a favour, but not after the flight. Perhaps a word with a fellow pilot/instructor might save the pilot's backside one day. We are all in this together, and I believe we have to do something about the current situation, so how about helping each other in this and other ways to improve how we do things. No one should be above receiving a bit of a reminder/suggestion to smarten up, however experienced they may be!

Clubs start the flying day with a deliberate check of the glider, the daily inspection. Why not start yours (if you did not do the DI) with a deliberate walk-around check, yes it has helped people avoid a flight in a damaged glider; I recall someone once noticed the safety pin was missing from the elevator bell crank pin! But most vital is the completion of a good, and thoroughly gone through pre-takeoff check. Then keep thinking of the options you have if the launch is interrupted for whatever reason at a low height. And keep that left hand against the spoiler lever!

# the 7 S's

**George Szukala**  
Cold Lake Soaring Club

In the 6/93 issue of *free flight*, Ian Oldaker wrote a good article on off-field landings which presented all the considerations a pilot must address in landing away from home. It's the kind of article which requires careful study. Study, as we all know is not just passive reading, but if conducted properly, is the dynamic analysis and reflection upon that which has just been read. In other words, it's hard work!

Now that we've all had a chance to study Ian's notes on off-field landings, it's time to present a short refresher and provide a ready-to-use in-flight checklist on how to pick a field. Field landings are a natural part of soaring and though many experienced pilots haven't had lots of field landings, all pilots need to prepare for the possibility of floating into a canola patch. Field selection at an early stage is critical to prevent panic decisions being made so I use a method known as the "7S" approach to field selection which I'd like to share with you. It's a memory aid used by helicopter pilots to select confined areas suitable for landing, and being the very resourceful chap that I am, I stole it from them.

It goes like this: SIZE, SHAPE, SLOPE, SURFACE, SURROUNDINGS, SHOOTs and SUN. Say it out loud to yourself three times and it'll be yours for life.

**Size** Make sure the size of the selected field is large enough to accommodate your glider and that the prevailing wind will allow the greatest length to be used. Factors like nearby roads and accessibility to buildings/phones, although important, should be lower down on the priority list. The objective here is to get you and glider down in one piece and without damage to either. You'd be amazed from what locations gliders can and have been retrieved, so if you find yourself in a spot of trouble don't pass up any field that you believe your skill will allow you to land in safely.

**Shape** Is the shape of the field conducive to a successful landing? In other words, the field doesn't have to be perfectly square

or rectangular, any shape will do as long as you can squeeze the glider in there. Golf fairways with 20 degree dog legs, stretches of abandoned road, gravel pits, meadows and, yes, even natural gas pipeline clearings will work. Again, be open minded with regard to field shape; abstract fields may look strange but may provide you with the escape that's required.

**Slope** See if you can detect any appreciable slope to your landing area. Slopes are important in conjunction with wind direction because this will determine if you can stop after touchdown. Each situation will have to be assessed on the circumstances presented in your flight. In some cases it may be possible to accept a downwind landing because the slope up will help in decelerating the glider after landing. Avoid choosing a field with a slope which crests in the centre of your landing area; it would be undesirable to land upslope, cross the apex and then be faced with a downhill slide into an obstruction or rough terrain.

**Surface** This should be fairly obvious to most folks. Inspection of the field is important so that you can negate the chances of being surprised in the last stages of approach. It's extremely hard to do a go-around in a glider! Besides looking at the obvious obstacles such as tractors, hay bales, large boulders, and trees, a pilot should consider choosing a field based on crop type or with low stubble so that the surface can be exposed to maximum inspection. In landing in tilled fields, consideration should be given to landing parallel to the furrows rather than across. Fallow fields usually offer the best possibilities for a good inspection and subsequent reasonable landings.

**Surroundings** This checklist item deals with trees or other factors which could influence how you would set up your approach. There are marked differences to landing in a field which has a clear, shallow approach rather than dropping in steeply over obstacles. Consideration should be given to picking an into-wind approach over low obstacles or through breaks in surrounding vegetation which will contribute to a shallow glide slope.

**Shoots** We're not talking about hunting here. This part deals with undershoots and overshoots to your selected field and how these aspects would affect your approach during its final stages. The best situation would involve a field within a field. In other words, if things really started to go from bad to worse during your approach and you encounter strong sink or lift, a landing in a field prior to, or past the one selected may turn out to be okay. Naturally, you would've focused your attention on the selected field from altitude and therefore, may not have noticed specific details of the fields surrounding your intended place of landing, so the ability to land your glider precisely comes into play here as it would with any aspect of off-field landings. An unintentional undershot or overshoot landing would obviously pose a degree of uncertainty with its

associated heightened level of anxiety which a pilot would like to avoid. The objective of SHOOTs in the checklist is to simply get you to think about them when making field selections from a comfortable altitude and to be aware of any consequences which may result in a botched approach.

**Sun** This final item may seem insignificant, but in fact plays a very important part in off-field selection. An approach into the sun will blind the pilot as he flares for landing and will therefore remove any capability the pilot has of distinguishing the field's subtle details that may have been overlooked during field selection from altitude. Ideally, one would like the sun to illuminate the field being landed upon while being at the pilot's rear hemisphere. Again, this is something to think about at altitude and is nice to have working for you in an off-field landing, but don't get too panicky if it doesn't fall in line with your plan, just be aware of it as a consideration.

In closing, use of this checklist will vary with aircraft type and pilot experience, skill level, and type or amount of off-field landing training one has gained. As it's not likely that off-field landings will vanish from our sport unless we all start flying motorgliders, checklists or mnemonics should be used where possible to aid field selection. Remember, "If you're not occasionally threatened with an outlanding on your cross-countries, you're not trying hard enough!"

So, taking every factor into consideration and making an early decision, what would our ideal field look like? Well, it would most likely be a level sod farm partitioned by low fences and the closest tree is in the next province. The approach would be into wind of course and we would be landing with the sun behind us. The farmer would have no field equipment out as it would've been put in the barn at day's end and any livestock would be penned. A well-oiled gravel road services this ideal farm and a gas station with pay phone is located only a mile away. After landing in this field and looking over your glider at those unsightly grass stains, the farmer comes out to greet you with a smile and beer in hand. You're invited in for a home-cooked supper and subsequently introduced to the farmer's daughter, who happens to love glider pilots because they are always landing on dad's sod without damaging the crop. During supper, farmer George mentions that he does his own crop dusting and never bothered to remove the towhook from his Pawnee. He believes that a towrope might still be in the back and offers to give you a tow back home next morning. I'm sure you get the picture!

*Size, shape, slope, surface, surroundings, shoots and sun.* Even if you just remember the headings, they will most likely prompt you to give some consideration to the factors affecting off-field landings and you will be able to pick fields like the one described above with confidence — although it may only be in your dreams. Happy landings. •



# incident reports

## THE UNFORGETTABLE GOLDEN MOMENT

Dave Burgess, Vancouver

I was flying in my Libelle at Golden, BC during the BC Soaring Safari and was just passing through 7000 feet after a period of scratching on the ridge. It looked like I would get an excellent flight after a rain day. I settled in the cockpit and adjusted the rudder pedals towards me. About a second later, I heard a muffled bang and the left pedal disappeared under my foot. I thought, "I bet the rudder cable failed."

I decided to keep going around the turn to head towards the airport and away from the mountains. I knew that rudder was not an essential flight control, but was surprised at how difficult it was to understand what the aircraft was doing. (Unknown to me at the time, the spring on the right rudder pedal was applying about 1/3 right rudder. Try flying this way as an experiment some time!) "If I can't control this, I will bail out" ran through my mind, surprisingly calmly.

At this point, the aircraft was headed approximately back towards the airport and I skidded out of the turn to try to determine how I could land the aircraft. The rudder cables on the Libelle run along the cockpit sides and appear under one's knee, so I thought there was a reasonable chance that I could retrieve the "live" end of the failed cable. After a desperate grab (it would have helped to loosen the shoulder straps) I got the cable. By pulling it forwards, then folding it back for extra friction I found the right rudder pedal alone could give me reasonable control. I now had some time to talk on the radio and practise flying the aircraft.

Right turns were quite normal, while left turns were clumsy at best. I decided on a right hand circuit. As my left hand was occupied with the cable, I left the spoilers where they stayed at the 3/4 open position for final. I did have to close them for a few seconds to avoid undershooting. Touch-down and rollout were uneventful — luckily there was no gusty crosswind.

The failure occurred at the front nicopress fitting at the end of the left rudder cable. The thimble was a slightly tight fit on the anchoring shaft. This caused the cable to flex slightly at the aft end of the swaged nicopress sleeve each time the rudder was moved, and eventually fail due to bending fatigue.

There is a service bulletin to inspect the rudder cables where they go through the S shaped pedal tubes, and I check for frayed cables every few DIs. However, the failed area of the cable up at the forward bulk-

head is difficult to see without removing the complete pedal assembly, and it is also difficult to determine which of the frayed wire ends are from the end of the cable, and which are breakage. The replacement and right hand cable's thimble ends have been verified to pivot freely on the anchor shaft to prevent the failure recurring.

What can be concluded from this near accident:

- I was lucky. Had this failure occurred on tow, or while I was flying near the ridge, recovery would have been difficult.

- I am suspicious that US and metric nicopress thimbles are slightly different sizes. Most gliders are made with metric hardware which may cause subtle problems during maintenance.

- The end of the nicopress sleeve is a likely place for cable failure. These sleeves are located near the ends of the cable — places that are often difficult to inspect.

- It gave me confidence knowing that the rudder is not an essential flight control. I knew that my chances of having a positive outcome for the situation were very good. The loss of elevator or aileron control probably gives much less chance of landing the glider in one piece.

- I have rehearsed bailout from the Libelle. However, it would be helpful to prethink the criteria for bailout. If I had been unable to control the glider, how much height would I have wasted? Would the bailout decision have been left too late? This must be balanced against the fact that only 70% of pilots survive after the decision to jump has been made.

- It is helpful to have some knowledge of the location and operation of systems on the aircraft.

- I could also have controlled the rudder by putting my toes behind the right pedal and pulling, but I didn't think of this until a few hours after I landed.

- Try flying with your left hand until you are proficient. If the right cable had failed, my right hand would have been busy and unavailable for flying. Many emergency situations may need an extra hand.

I hope this story gives you some food for thought during your next DI and flight. •

## A REPORT ON REPORTS

As of the beginning of July, very few accident and incident reports have been received. So far I received four notifications

of insurance claims but no associated accident reports, one substantial damage with no claim, one gear-up landing with no damage, and some miscellaneous tidbits.

Some frightening incidents were also reported — one of Canada's most experienced and best known pilots forgot to connect the ailerons and actually took off, though not too high (thanks for the report) and a rudder cable failed in flight in a Libelle (*see story opposite*). This should give a heads up notice to all gliders having in-flight adjustable rudder pedals. Cables can and do wear and fatigue around pulleys, through fairleads, and at points of connection!

Please do not forget to send in your incident reports to SAC. You may save someone else's life as a result. Remember, *do not substitute safety for convenience*.

George Eckschmiedt  
FT&S committee

### ACCIDENTS & INCIDENTS

7 May SOSA, Pawnee. Taxied into soft area of airfield and tipped onto nose, prop destroyed.

14 May SOSA, ASW-15. Hit runway taxi light, minor wingtip damage.

20 May SOSA, Hornet GQMB. Gear up landing, no damage.

21 May Bluenose, K7 FOZA. Heavy landing, no damage to ship, minor injuries to P1 and P2.

22 May Air Sailing, ASK-13 FYEQ. Pilot caught finger ring on edge of vent window, broke canopy.

23 May COSA, Astir GYJZ. Hit fence on final of outlanding. Section of fence knocked down and some crop damage, no info on glider.

3 June Regina, Twin Astir GSLG. Hard landing after pilot's hand slipped off spoiler control.

5 June Champlain, 2-22E FWTY. On turning off runway to clear approach, pilot rolled glider into a shallow ditch, minor damage.

5 June Bluenose, K7 FOZA. Under-shoot with heavy landing, substantial glider damage, no injuries.

26 June Toronto, Puchacz FKHX. Hard outlanding in field next to club.

3 July Edmonton, ASW-20FP GULX. Hit rocks on outlanding, some belly and wing leading edge damage.

8 July Regina, Open Cirrus FBMX. Gear up landing with minor damage.

10 July Vancouver, Blanik L-23 GVSK. Catapulted into air before takeoff (?), heavy landing, no damage.

17 July Rideau, Breguet 905-5 FZDM. Towplane lost power after takeoff, some damage to glider on landing, tug a write-off (no claim).

# club news

## MONTREAL SOARING COUNCIL 94 SOARING ?? SEASON

To date, the 1994 soaring season at MSC has been one of the wettest, windiest, and woolliest in recent years. At one point in June, we had nine solid days of rain with only a half day let-up. The weather has been more akin to a wet autumn, sporadically sprinkled with a few days of scorching hot end July/early August type stuff.

Some suggestion was made that we rename our club the Montreal Grass Cutting & Mosquito Farming in Hip Waders Club, but the acronym is too unwieldy. Besides, it might give potential new members the idea that we don't actually glide, soar, or even vainly haul ourselves through the water-laden air. At least the intros didn't complain too much about turbulence during their flights ... but what do the advanced students train on when you talk about thermals?

THERMALS?

To be fair, we've had a few (and I mean few) days of relatively decent weather — mostly midweek.

On the bright side (is that the sun breaking through!, open the hangar doors!) we have made a lot of improvements around the site. Our second 2-33 is back in service after a cleanup and a new paint job; all three L-19s are just waiting to tow, and our LS-1 has a new canopy. Improved showers and sewage system components were installed thanks to our affable clubhouse director and assistant CFI (notice the order) Bill Roach. The only downside is that our beloved DG-300 isn't back from the repair shop. But then what would we do with it?

The Eastern instructors' course is being held at MSC July 16-23. Then, July 25-29, we are hosting a friendly soaring competition for sports, club and 1-26 type sailplanes.

Peter Kom, MSC



from  
Seattle  
Glider  
Council  
"Towline"

## THE WONDERS OF GPS

Last winter I was flying in Florida for several weeks with a *Garmin 55* GPS mounted on my panel.

I am amazed at how useful this instrument is. You no longer need either a map or a compass. You never look at the ground except to take turnpoint pictures and you always know your exact track over the ground.

I have set the display to show five items on the screen simultaneously —

<i>GOTO</i>	name of turnpoint
<i>BEARING</i>	direction to turnpoint
<i>TRACK</i>	direction of travel over the ground
<i>DISTANCE</i>	distance to the turnpoint
<i>GRD SPEED</i>	speed over the ground

The units can be set to nautical miles, statute miles or kilometres. When *TRACK* and *BEARING* are the same you are travelling directly toward the turnpoint. *TRACK* is updated so quickly (once per second) that it is possible to use the GPS to fly in cloud (and I'm told that contestants at the world contest in Sweden flew in cloud using GPS).

During a normal thermal circle *TRACK* seems to be about 10 to 20 degrees behind the instantaneous heading.

When you purposely fly off course to go to a thermal the difference between *TRACK* and *BEARING* gives you an exact measure of your deviation, while *BEARING* is constantly updated.

I was expecting to have to buy a new final glide computer which would accept the output from the GPS but I find that it is very easy to update the computer distance manually and of course you get a good wind estimate by checking the difference between *GROUND SPEED* and your airspeed.

You probably really don't need an electronic final glide computer — a plastic circular slide rule is all that's necessary.

The GPS is a truly revolutionary new instrument which will make radical changes in your cockpit activity. Any pilot without GPS will be at a severe disadvantage in a contest. I'm not sure that this is good, but I believe it is true.

It certainly is good for safety because you no longer have any need to have your eyes in the cockpit trying to figure out from a map where you are. You can spend much more time making soaring decisions because navigation is no longer necessary, at least until your battery fails or someone turns off the satellites for a while.

Walter Weir, COSA

## THE WORLD RECORD FOR EXCUSES

Walter Weir, COSA

May 10, 1994 — Keystone Gliderport, Julian Pennsylvania

It was a beautiful day for soaring but not a ridge day. I had declared a 750 km out and return task which I thought might be possible if the thermals were wonderful. As it turned out they were a bit too wonderful and it was already overdeveloping with some very large rain squalls blocking my way when I was only 50 km out. I tried to find a way around them but new ones seemed to develop and block each plan I came up with. Finally I gave up, climbed as high as I could (about 7000 agl) and started back to the gliderport.

Meanwhile back at the field, Bernie Palfreeman of MSC had his takeoff delayed by a squall but was now in the air with about ten Americans, flying locally. It was coming up to 12 noon and when I got a chance I took a quick glance at the sun when it was behind enough cloud so that I could see the disk. Sure enough, as predicted, there was a big bite out of the top right side. By 1:20 there was only a sliver of sun left, and although it was very light out, the ground looked dull as if it were in the shade. We all agreed it was cooling off. By now the sky was clear of cloud and the whole dozen of us were in two or three gaggles scratching for lift.

We hung on until about 2 pm but then, within about 15 minutes, we all landed. Shot down by an eclipse of the sun — a world record excuse for sure!

(Dave Noyes of Columbus, Ohio also flew out of Keystone Gliderport that day in his Ventus motorglider. He started earlier and beat the squalls in his run to the southwest, away from the path of the eclipse. At the height of the eclipse he was past Cumberland, about 200 km away. He said he had a period of scratching but managed to hang on without using his motor. He was our only survivor. He arrived back at Keystone several hours after we were all down.)

## LAKE EFFECT A KINKY TALE

Gord MacDonald  
from *SOSA News*

When it happened, it was one of life's embarrassing moments. But now, given the passage of time, it seems almost humorous ...

I had been flying our new sailplane, the Polish Pirat, for a couple of hours, in quite indifferent lift. I was becoming both bored and weary with the effort of staying up, and

## "The Book of the Best" What happened to the club copy?

This new 65 page reference by Ursula Wiese (in loose leaf form for easy updating and storage in a 3-ring binder) presents the evolution of soaring achievement in Canada. With extensive flight and aircraft data, it is a comprehensive history of records and diamonds flown, trophy recipients for each year's best flights, national contest champions, and awards to pilots who gave freely of their time for the betterment of the sport.

A personal copy can be yours for \$10 (sales tax included for Ontario residents). Order now through the national office or the *free flight* address.

A free copy has been sent to every club for the general enjoyment of your members. To the executive member who picked up the club mail — DO NOT FILE THIS PACKAGE AWAY — *its intended purpose is being thwarted if it is hiding in your office.* We know this is occurring already. Please put it in a binder and leave it in the clubhouse or other spot where club members can read it.

Ursula asks that any errors or omissions you find be forwarded to her for subsequent page revisions.

my bladder was beginning to make demands that would have to be answered soon.

So I decided to come in, and was just lining up for the circuit when — wham! — one wing abruptly tilted skyward. Instinctively, I pressed the stick hard against the uprising wing and entered the surge of the thermal.

It was beautiful, strong lift. Happily circling, I quickly forgot my boredom. But soon, the call of nature became more insistent, and could no longer be ignored.

The Pirat had a "relief" system, consisting of a rubber cup attached to a long tube leading through the cockpit floor to the outside. As the need had not previously arisen, none of us had used the tube. Besides, we were all proud of our new sailplane, and were anxious to keep it in pristine condition. In fact, there was a tacit understanding among the partners that the tube was to be used only in dire emergencies.

But there I was, being transported upward in what was rapidly becoming the best thermal of the season. And I had to GO. If that isn't an emergency situation, what is? Sooner or later, someone had to give the tube its christening, and I could think of no more deserving — or eager — candidate than poor, twitchy me.

The operation seemed simple enough, except that I hadn't counted on the major impediment of the tightened parachute straps between my legs. Not having been signed out for relief tubes, I hadn't appreciated the advantages of unzipping before buckling up. Anyone watching the sailplane during this period of intense personal struggle might have wondered as to just what type of aerobatics I was trying to perform, but somehow I managed to stay in the thermal while getting everything into position.

Such sweet relief. I began to feel rather pleased with my dexterity, neatly flying the thermal with the other hand.

Now, if there's one thing I should have learned from gliding, it's this: any time you feel cocky (so to speak) about your flying ability, you're due for a fall — figuratively, and often enough, literally. In this case, retribution was not long in coming — although it came in a most unexpected way. My hand, which had become pleasantly warm holding the cup, now experienced a different sensation. It couldn't be of course, but my hand, and indeed much of the surrounding area, seemed to be getting rather damp. In utter disbelief I stole a downward glance. My cup truly runneth over.

Now, there was no question that I leave the thermal and land. Moments before, I had been so proud of my ability to hold the cup while thermaling. Now, my major concern was to try to keep it from spilling even more of its sloshing contents on the way down. Coming in, I passed high over the flight line, headed for the far end of the runway. I figured I might be left alone there for a while, perhaps even long enough to dry out. As I had hoped, no one showed any interest in making the trek to retrieve me.

Later, after airing the cockpit and with a change of clothing I took a close look at the relief tube plumbing. There, in the space under the cockpit floor, I discovered a sharp, 180 degree kink in the tubing. Whether this was an accident of assembly, or a practical joke by some mischievous Polish aircraft worker, we'll never know.

In the evening, I joined other members in the clubhouse. When they asked me how my flight had been, I told them, without elaboration, that I had been shot down by lake effect. •



# SAC affairs

## I NEED YOUR TROPHY FLIGHT DATA

### THE "MEMBERSHIP METER" NOW AN ONGOING HOWGOZIT

Club (by Zone)	Membership		
	'93	'94 to date	%
Bluenose	39	33	84
Champlain	38	43	113
Mont Valin	6	5	83
Montreal	107	82	76
Quebec	36	28	77
Outardes	30	23	76
Air Sailing	24	28	116
Base Borden	18	10	55
Beaver Valley	8	6	75
Bonnechere	6	0	-
COSA	26	29	111
Guelph	25	29	116
Erin	34	35	102
Gatineau	95	80	84
Kawartha	10	0	-
London	43	35	81
Rideau	19	12	63
Rideau Valley	40	25	62
SOSA	106	97	91
Toronto	21	0	-
Windsor	11	0	-
York	91	0	-
Gravelbourg	6	6	100
Prince Albert	9	10	111
Regina	30	24	80
Saskatoon	10	11	110
Swan Valley	6	6	100
Westman	9	4	44
Winnipeg	66	63	95
Cold Lake	17	22	129
Cu Nim	60	58	96
Edmonton	69	47	68
Grande Prairie	3	7	233
Alberni Valley	11	9	81
ASTRA	0	2	-
Bulkley Valley	9	8	88
Vancouver	116	99	85
Individual	6	7	116
<b>Totals</b>	<b>1288</b>	<b>983</b>	<b>76</b>

Beginning in this issue Joan will be providing *free flight* ongoing membership data by club. My bet is that all members will note the progression of their club membership relative to the previous year, and it might also give the hint to some members that their club is not promptly forwarding their SAC memberships to our office.

I plan to use *free flight* more and more to focus all of our energy toward our forthcoming 5 year plan.

**Pierre Pepin,**  
SAC President

*Note from Joan:* The membership numbers this year are as of 21 July. Bonnechere is inactive this year, and I have heard (but have not received any formal notification) that COSA and Kawartha have combined their operations at the Kawartha field.

The other clubs in Ontario simply have not passed their members SAC membership fee on to the office. Individual members of these clubs should be concerned since they are on quite thin ice regarding their SAC glider insurance and have received this and their last *free flight* on sufferance. If you don't see your next magazine, don't call me, call your club Treasurer.

### MIKE PREAMP

Many members in the gliding fraternity are still using older radios that require the use of carbon microphones. While these mikes are generally good, their design dates from Alexander Graham Bell! Also, they have the unfortunate ability to lose function over time as the carbon particles pack together. The usual remedy is to rap it sharply on the side of your fuselage and try again, but what about the carbon mike in your oxygen mask? A better solution is to use the newer dynamic microphones on the market (such as the Telex TR-66T or others).

The following circuit will amplify and provide proper levels into the older radios. The circuit works well with most dynamics that I have tried including the European boom mikes. The circuit is very simple and can be made small enough to fit inside the microphone plug! The parts will cost about \$7 including the small circuit board. The best supplier for the parts is Active Components, a retail chain with stores in large cities. The only part which will be hard to get is the ferrite bead which is needed to inhibit the input RF from the transmitter since its amplifier is a very high impedance type. I can supply some beads, but another source is Digi-Key in Thief River Falls, MN. The part number is #p9822 in their catalogue (\$0.89 for 10). Call 1-800-344-4539 for the catalogue.

**Paul Moffat,** Radio committee

It's time again to send me data on your flights for SAC trophies; *BAIC* — best flight of the year; *Canadair* — 5 best flights; *"200"* — 5 best flights by a pilot with less than 200 hours P1 at the start of the year; and the *Stachow* for the greatest altitude. For you beginning pilots, why not win the *Jonathan Livingston Seagull* trophy by being the youngest pilot to complete the Silver badge in 1994?

The rules for the trophies this year are basically unchanged; FAI type declarations and turnpoint verifications are required, but barographs are not needed except for altitude flights. Certification by an official observer is also required. Flights are scored at one point per kilometre with bonus factors as follows:

- PST legs or goals achieved (1.25),
- declared poly, O&R, or triangles completed (1.50);
- speeds more than 70 km/h (.58 + .006 x speed);
- new record (1.2)
- SAC sailplane handicaps are applied.
- A formula is also available to convert height gain into trophy points.

The conditions for PST flights are clarified as follows:

- a PST task cannot be mixed with a declared task. Use either one or the other.
- turnpoints must be from a pre-established list such as those from a contest or at club level. Pilots cannot simply choose them as convenient during a flight.
- where turnpoint/photo target pairs have not been set up for photos, then FAI turnpoint photos are to be taken.
- turnpoints may be used again after using at least two other turnpoints (no out-and-return legs).
- PST tasks flown at contests are acceptable under the rules of that contest.

Entry forms may be obtained from the Trophy and Claims chairman, or from *free flight*, or the SAC office. The forms also contain additional information. My advice is to document flights as soon as possible after you fly them as it is difficult to find the data at year's end. We hope you will enter.

**Harold Eley,** SAC Trophy chairman

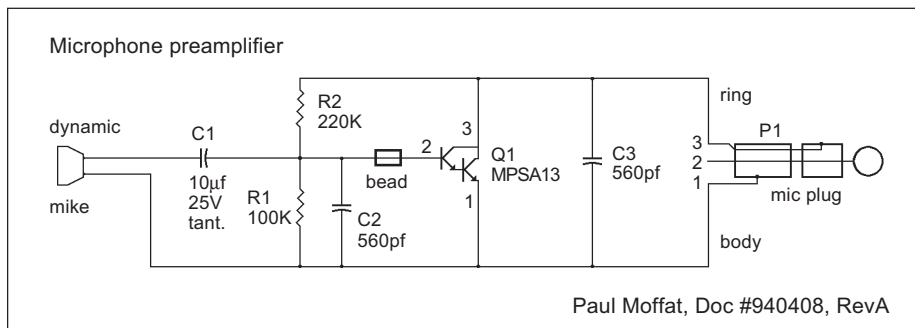



## HORIZON

*Horizon how you beckon in the distance,  
only to recede as we approach, yet rewarding us with  
sights of splendour you constantly unroll before us to behold.  
As you urge us on you are ever expanding.  
In flight as in life or in learning we are striving to see more,  
yet we shall never touch the line where sky and earth do meet.*

*Karl Raupeisen SOSA July 1994*

Trophy application forms are also mailed out to clubs at the beginning of the season from the National office, however, it seems like the responsible persons such as the CFI or the club SOO are not getting them or passing them on to pilots which have made potential trophy flights. Forms are useless if no one knows of them! I know I wouldn't like to get the BAIC trophy for a flight I suspected had been bettered by another pilot, even if the pilot knew about the trophy but didn't bother to apply for it. The system only works well if you use it.

**Tony**

### SAC OFFICE MOVES

SAC is soon moving to a new office. The move has been prompted by the prospect of higher rents at the current location and to improve office conditions for Joan. The Aero Club of Canada, who shared the space and the rent with us, is moving to reduce their expenses (which are becoming considerable according to a report from ACC president Bob Carlson). Joan also was becoming increasingly concerned with personal security at the present location and there was also no parking available.

Effective **1 September**, the new address and telephone will be:

**Suite 111 – 1090 Ambleside Dr  
Ottawa, ON K2B 8G7  
(613) 829-0536, fax 829-9497**

### ONTARIO SOARING ASSN

Good news! We at OSA just received the first part of our 94/95 funding from the Ministry of Culture, Tourism & Recreation. The initial payment was \$7495 and we are hoping for a similar amount in a couple of months. It looks like our funding could increase this year. Checks will soon be in the mail to member clubs which will help offset some of the costs of the Provincial and National championships as well as instructor training.

"Participation Development" is a phrase that will be used more as we head into our Fall planning process. How do we encourage soaring pilots to be more active in their clubs and in the sport? Several groups are working on different projects and they are paying off. Pilots from several of the Toronto area clubs got together recently to share thoughts on how they could cooperate better and increase participation in the sport, and other get-togethers are planned as we move into the season.

Even better than getting money is people donating their time. A York Soaring pilot, Milosz Zeminek and his fellow students at Waterloo have completed a marketing plan on how to promote the sport.

Would you like to participate in informal XC competition with your peers? If so, the provincial Cross-country Ladder is for you. All clubs have received application forms and rules. Talk to your Ladder OO or CFI.

**Ken Winthrop**, OSA president

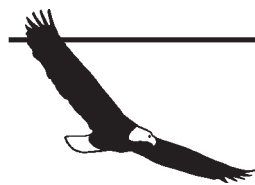

## Coming Events

**27-28 Aug Tillsonburg Air Show**, airport north of Tillsonburg, ON on Hwy 19. Over 100 exhibitors, aircraft, balloons, classic cars, trucks. Shuttle bus service, RV parking. Contact (519) 842-9805.

**3-5 Sep Fun Gliding Contest**, Air Sailing Club, all welcome. Contact: Richard Longhurst (416) 391-3100 ext 250 (W), fax 391-2748.

**6-10 Oct Cowley Wave Camp**, contact Tony Burton for details, (403) 625-4563.

**3-5 Mar 95 SAC Fiftieth Anniversary AGM**, Ottawa, hosted by Gatineau Gliding Club. Contact: Beth McCollum (613) 692-2227. Any workshop ideas or suggestions will be passed to Glen Lockhard.

**date TBC 1995 National Gliding Championships**, Pendleton, ON hosted by Gatineau Gliding Club, more info later.

## SAC Directors & Officers

### PRESIDENT & QUEBEC Zone

Pierre Pepin (1993)  
590 rue Townshend  
St-Lambert, PQ J4R 1M5  
(514) 671-6594 (H)

### VP & PACIFIC Zone

Harald Tilgner (1994)  
50090 Lookout Road  
RR2, Sardis, BC V2R 1B1  
(604) 858-4312 (H)  
(604) 521-5501 (VSA)

### ATLANTIC Zone

Gordon Waugh (1993)  
5546 Sentinel Square  
Halifax, NS B3K 4A9  
(902) 455-4045 (H)

### ONTARIO Zone

Richard Longhurst (1993)  
100 – 1446 Don Mills Road  
Don Mills, ON M3B 3N6  
(416) 391-2900 (H)  
(416) 391-3100 ext 250 (B)

### PRAIRIE Zone

Paul Moffat (1994)  
1745 King Edward Street  
Winnipeg, MB R2R 0M3  
(204) 633-5221 (H&F)  
(204) 957-2827 (B)

### ALBERTA Zone

John Broomhall (1994)  
1040 - 107 Street  
Edmonton, AB T6J 6H2  
(403) 438-3268 (H)  
(403) 423-4730 (B)

### Director-at-Large

George Dunbar (1993)  
1419 Chardie Place SW  
Calgary, AB T2V 2T7  
(403) 255-7586 (H)

### Director-at-Large

Chris Eaves (1994)  
185 Canterbury Drive  
Dorchester, ON N0L 1G3  
(519) 268-8973 (H)  
(519) 452-1240 (B)

### Executive Secretary

Joan McCagg  
111 - 1090 Ambleside Dr  
Ottawa, ON K2B 8G7  
(613) 829-0536 (B)  
(613) 829-9497 (F)

### Treasurer

Jim McCollum  
6507 Bunker Road  
Manotick, ON K4M 1B3  
(613) 692-2227 (H)

## Committees

### Insurance

Richard Longhurst  
100 – 1446 Don Mills Road  
Don Mills, ON M3B 3N6  
(416) 391-2900 (H)  
(416) 391-3100 ext 250 (B)  
Mbr: Doug Eaton

### Air Cadets

Bob Mercer, Box 636  
Hudson, PQ J0P 1H0  
(514) 458-4627 (H)

### Airspace

position to be filled

### Contest Letters

Robert Binette  
5140 St-Patrick  
Montreal, PQ H4E 4N5  
(514) 849-5910 (H)

### FAI Awards

Walter Weir  
3 Sumac Court  
Burketon, ON L0B 1B0  
(after 15 Sept)

### FAI Records

Dave Hennigar  
404 Moray Street  
Winnipeg, MB R3J 3A5  
(204) 837-1585 (H)

### Fit Training & Safety

Ian Oldaker  
142 Mill Street  
Halton Hills, ON L7G 2C1  
(905) 877-1581 (H)  
(905) 823-8006 (F)

Mbrs: Mike Apps  
Ken Brewin  
Geo. Eckschmiedt  
Fred Kisil  
Paul Moggach  
Richard Officer  
Gilles Séguin  
Richard Vine

### Free Flight

Tony Burton,  
Box 1916  
Claresholm, AB T0L 0T0  
(403) 625-4563 (H&F)

### Historical

Christine Firth  
23 rue Barette  
Hull, PQ J9A 1B9  
(819) 770-3016 (H)

### Medical

Dr. Peter Perry  
64 Blair Road  
Cambridge, ON N1S 2J1  
(519) 623-1092 (H)  
Mbr: Dr. W. Delaney

### Meteorology

Stephen Foster  
10 Blyth Street, Stn B  
Richmond Hill, ON L4E 2X7  
(519) 623-1092 (H)

### Publicity

Pierre Tourangeau  
5693 - 1 Eire Avenue  
Montreal, PQ H1Y 3A3  
(514) 722-2085 (H)

### Radio & Comm

Paul Moffat  
see Prairie Zone Director

### Sporting

Charles Yeates  
110 - 105 Dunbrack Street  
Halifax, NS B3M 3G7  
(902) 443-0094 (H)  
Mbrs: George Dunbar  
Robert DiPietro

### Statistics

Randy Saueracker  
1413 – 7 Avenue  
Cold Lake, AB T0A 0V2  
(403) 639-4049 (H)  
(403) 594-2139 (F)

### Technical

Chris Eaves  
see Director at Large  
Mbr: Herb Lach

### Trophy Claims

Harold Eley  
4136 Argyle Street  
Regina, SK S4S 3L7  
(306) 584-5712 (H)

# FAI badges

## Walter Weir

3 Sumac Court, Burketon, ON L0B 1B0 (after 15 Sept)

The following Badges and Badge legs were recorded in the Canadian Soaring Register during the period 2 May to 28 June 1994.

 Note my address change above. And please mail badge application forms to me — not to the SAC national office.

### 1000 km DIPLOME

#6 Wilfried Krueger SOSA 1005.2 km LS-6b Julian, PA

### SILVER ALTITUDE

Peter Vados SOSA 1168 m 1-26 Rockton, ON  
Karin Michel Cu Nim 2340 m Jantar Std 2 Black Diamond, AB

### SILVER DURATION

Brian Esplin Vancouver 5:14 h Blanik L-23 Hope, BC  
Karin Michel Cu Nim 5:22 h Jantar Std 2 Black Diamond, BC

### C BADGE

2421 Keith Pritchard Guelph  
2422 Brian Esplin Vancouver 5:14 h Blanik L-23 Hope, BC  
2423 Harold Porter Edmonton 1:37 h 2-33 Chipman, AB  
2424 Karin Michel Cu Nim 5:22 h Jantar Std 2 Black Diamond, AB

Congratulations to Wilf Krueger for Canada's sixth 1000 km Diplome. How about a story for *free flight*, Wilf? By the way, please note that I am moving soon, the new address is listed above and I will have the new telephone number by the next issue.

## SPORTING CODE AMENDMENT

The following is an amendment to the FAI Sporting Code Section 3 which will take effect **1 Oct 1994**. It applies to the use of "electronic" barographs for records and/or badges. As far as I know the only approved barograph in this category is the EW barograph.

### 2.10.1 Electronic Barographs

Electronic barographs which have been tested and accepted from a technical standpoint by the NAC of the nation of origin of the barograph manufacturer and also by two other NACs, may be used for flight validation. IGC reserves the right to carry out further assessments. For records, the electronic barograph must be fitted to the glider by an OO before flight. The OO's identification mark on the barogram before flight (para 8.1(h)) is not necessary for electronic barographs, however an OO must supervise the removal of the electronic barograph from the glider and shall then take charge of it until the flight data is printed out. The OO then confirms that the date and time on the printout is correct and that the date and times of the altitudes and other flight data recorded and printed out correspond to the date and times of the flight concerned, and correspond with other relevant aspects of the claimed performance. The following provisions also apply:

Either a) the Official Observer enters a secret multi-character code into the barograph's memory before flight. A second entry of this code shall be required to retrieve the stored data.

Or b) the following provisos must be satisfied:

1) The barograph incorporates a continuous date and time facility which cannot be altered without the fact of such alteration being automatically reported on all printouts of data from its memory recorded prior to the alteration; and

2) The OO is able to verify the date and time of the takeoff and landing of the glider on the flight concerned. If the OO has not personally witnessed these events, he should take evidence from other witnesses in order to satisfy himself that the events are correctly described in the record and printout from the electronic barograph.

## A NEW WAY TO DECLARE DISTANCE RECORDS

The annual meeting of the International Gliding Commission, held this March in Spain, began consideration of allowing pilots to fly distance records (and even closed course Diamond distance flights) without the requirement for the turnpoints to be declared prior to takeoff. On any flight containing turnpoints, pilots would be free to fly as far as possible and declare achieved turnpoints *after* the flight is completed.

This proposed change to the Sporting Code was placed before the IGC by Herbert Pirker of the Austrian Aeroclub. His argument was that the current constraint on distance records is unreasonable and contradictory in its requirement in that: first, for a distance record the pilot has to gain the highest possible distance out of his flight for the given conditions while second, self-limiting his performance before the flight by predeclaring the distance he intends to fly. Using another sport as an example, our current rules would require the Olympic javelin thrower to claim a record only if he said exactly how far the record throw would go! How this concept will be incorporated into the Sporting Code is now under study.

Other Sporting Code matters:

- Correction to Edition 6 of the *FAI Badge & Records Procedures* guidebook — para 3.6.c3 — delete reference to Gold or Diamond in distance flights. Landing 50 kilometres or more from an achieved turnpoint on *any* flight is sufficient to claim Silver distance.

Tony Burton



# FAI records

**Dave Hennigar** 404 Moray Street  
Winnipeg, MB R3J 3A5 (204) 837-1585 H

The following record flights have been approved:

**750 km O & R speed**, Open, citizens, 145.0 km/h, 12 May 94, Walter Weir, ASW-20B, C-GGWW. Flown from Keystone, PA with the turnpoint at Falling Spring, VA. This flight fills in the last remaining unclaimed record in the Open list, citizen.

**300 km speed to goal**, Open (not FAI), citizens, 145.9 km/h, 12 May 94, Walter Weir, ASW-20B, C-GGWW. Flown from Keystone, PA to the goal at Falling Spring, VA. The only prior record in this category was the *territorial* flight by Wolf Mix in 1966 at 108.6 km/h which still stands.

**200 km triangle speed**, Open (not FAI), citizens, 116.4 km/h, 21 Feb 94, Charles Yeates, Lak-12, VH-XQR. Flown from Waikerie, Australia with turnpoints at Alawoona silo and Yamba roadhouse. The current *territorial* record is 110.6 km/h set by John Firth in 1984 stands.

# Trading Post

## SINGLE SEAT

**1-26C**, C-GNYB, 1260h, basic instruments, no trailer. \$6000 obo. MSC club ship. Call O. Maranta (613) 678-5197.

**1-23 Std**, CF-ZBR, 1951 ser#16. Full overhaul, new paint, regular and sport canopies, encl trailer. Call Don Sutherland at (604) 325-5016, leave message.

**Tern**, 1971 wood homebuilt, 30:1 performance, comes with encl metal trailer, chute, and radio. \$5000 or best offer. Chris Gadsby (403) 283-2411.

**M-100**, C-FRIV, Ka6E perf, very short field perf, aerobatic, excellent cond, cockpit recently refurbished, elec vario, radio, O2, chute, encl metal trailer. Asking \$9500. Dave Harper (905) 896-3758 (H), or Garfield Ingram (416) 239-9740 (B) 239-7465 (H).

**Zugvogel IIIB**, 17m, almost 40:1, good condition, complete with radio, instruments, barograph, trailer. Helmut Wieland (613) 541-6606 (B), 548-7564 (H).

**Monerai**, C-FEUC, vg cond, basic instruments, audio vario, netto, panel mount TR-720 radio, encl steel trailer. \$7200. Struan Vaughan (403) 362-5837.

**Monerai**, C-GJUT, excellent condition, low hours, basic instruments with audio vario, encl metal trailer, wing stands. \$5700 obo. Chute available. David Ellis (705) 687-2365 (H), 645-5272 (B).

**HP11A**, C-FUKB, 518 h, standard instruments, CB radio, open trailer available. Highest performance per dollar, has done Gold and Diamond flights. After spring with fresh inspection, \$10,900. Bob Patterson (905) 457-5238, 9 to 9.

**SH-1 Austria**, refurbished in '91, trailer, chute, wing & tail covers, final glide calc. Bob Kurzwehmart, (519) 658-6334.

**HP-16**, C-GAUZ, 395 h, excellent workmanship & cond, standard instruments. Encl alum trailer avail. Also avail: Security chute, Narco radio, Winter baro, O2 tank and reg. Must sell - \$10,900 obo. Call Eric Ketonen Sr. (705) 799-6623 (H), 748-7953 (B).

**KW-45**, CF-SNZ, 500h, homebuilt glass fuselage with Open Cirrus wings, tinted canopy, radio, O2, llec vario system, encl alum trailer. \$17,000. Fred Wollrad (403) 479-2886 or Harold (403) 474-0139.

**ASW-15**, C-FKGB, 960h, Ball & PZL varios, constant flow O2 system, fuse & tail refinished in '91, ballast bags (not installed), Schleicher soft top trailer. Asking \$US15,800 with partway delivery possible. Kelly Allardyce (204) 661-0887 (H), 987-6390 (W).

**Jantar Std 2**, C-GMSG, 780 h, good cond, never damaged, all ADs. Schuemann & Ball varios, radio, O2, chute, metal encl trailer. \$US21,000 obo. Will deliver in western NA. Fred Guest (403) 289-8820 or Al Poldas (403) 271-8929 (H), 287-0144 (W).

**ASW-19B**, C-GGMN, 1979, 930h, all ADs. Dittel radio, Skytronics vario/computer, Security chute, Eberle glass trailer. All in good condition, \$31,000. Michael Stieber (613) 832-1276.

**PIK-20EII**, C-FIGW, in excellent condition, 465h, engine 135h, Varicalc vario/computer, Becker radio, Bohli, Security 150, one person rigging system, factory trailer, mainwheel dolly, expensive spares. \$US42,000. Len Gelfand (613) 749-5101.

## TWO PLACE

**2-22E**, C-FACC, 1965, good condition. \$4500. Covered trailer (needs work), \$500 with glider only. Call Steve Patton, (604) 536-2819.

**Gemini**, all metal with fibreglass fuselage, outstanding 37:1 sailplane holds national records - 500 & 100 km triangle speed, etc. Basic instruments, 2 chutes, trailer. Jean Lapierre (514) 655-7766.

## MISCELLANEOUS

**For sale**, unused odd-sized 4.95" x 3.5" **glider tire** (fits Skylark 4), static conducting, 6 ply, cost me £27. **Peravia barograph**, excellent condition, the ultimate in barograph design - no ink, no smoke, punches holes in waxed paper every 4 seconds. Max Harris, (519) 842-7481. Make me an offer.

**Wanted** - LK-10 trailer and information on LK-10s in Canada. Call Herrie ten Cate (416) 604-3579 (H).

**Wanted** - Trailer for L-13. Call Julien at (604) 435-4239 H, 432-5352 B.

**Wanted** - Radair 10s radios in working cond or for parts. Pierre Bertrand (514) 421-6373 (collect ok).

**Parachutes**, three Cu Nim club military chutes, \$250 each. Dave Fowlow (403) 289-9477 (H).

**Wanted** - Parachute, thinback style. Also will trade electronic Ball vario for a mechanical vario. Mike Cook (604) 427-5471.

**Wanted** - wing or wings for Grob Astir CS. Call Lee at (905) 840-2932 H, evenings only.

**COSA** is looking for a reasonably priced single-seater suitable for club use. Contact Bob Legere (905) 668-5111 (H), (416) 412-6550 (B).

### Backpack chutes - \$1050

- New container in choice of colours
- 28 foot round canopy
- 2 years free repack
- 5 years parts and labour guarantee

Dave Puckrin  
(403) 459-8535 home, 451-3660 work

## MAGAZINES

**SOARING** - the journal of the Soaring Society of America. International subscriptions \$US35 second class. Box E, Hobbs, NM 88241 (505) 392-1177.

**SOARING PILOT** - bimonthly soaring news, views, and safety features from Knauff & Grove Publishers. New large format. \$US20, add \$8 for first class/foreign postage. Box 1145, Frederick, MD 21702-0145 USA.

**NEW ZEALAND GLIDING KIWI** - the official publication for the 1995 World Gliding Championships at Omarama and the bi-monthly journal of the N.Z. Gliding Association. Editor, John Roake. \$US25/year. N.Z. Gliding Kiwi, Private Bag, Tauranga, N.Z.

**SAILPLANE & GLIDING** - the only authoritative British magazine devoted entirely to gliding. 52 pp, bi-monthly. Cdn. agent Terry Beasley, Box 169, L'Original, ON K0B 1K0 or to BGA, Kimberley House, Vaughan Way, Leicester, LE1 4SG, England. £15.50 per annum (US\$30) or US\$40 air.

**AUSTRALIAN GLIDING** - the journal of the Gliding Federation of Australia. Published monthly. \$A40.50 surface mail, \$A55 airmail per annum. Payable on an Australian bank, international money order, Visa, Mastercard. (No US\$ personal checks.) Box 1650, GPO, Adelaide, South Australia 5001.

## SOLAR CELL BATTERY CHARGERS

### Features:

- new, maximum efficiency design
- very light but tough construction
- small size
- low reflection
- modular design
- very easy hookup and installation
- units for 12V and 14V batteries
- diode protected

Specs:	12V	14V
voltage	14.5	16.5
current	150-170ma	150-170ma
size	5.25" x 8.5"	5.25" x 10"
price	\$95	\$110

**MZ Supplies** 1450 Goth Avenue  
Gloucester, Ont K1T 1E4  
(613) 523-2581

## SUPPLIERS

### REPAIRS & MAINT.

**Sunaero Aviation.** Glider repairs in fibreglass, wood, & metal. Jerry Vesely, Box 1928, Claresholm, AB T0L 0T0 (403) 625-3155 (B), 625-2281 (Fax).

### INSTRUMENTS & OTHER STUFF

**Instruments for sale** - best prices anywhere. Call for list and prices for vario, altimeter, airspeed, T&B, G-meter, compass, radio, etc. Lee (905) 840-2932 H, evenings only.

**Barograph calibration**, most makes and models. Walter Chmela (416) 221-3888 (B) 223-6487 (H).

**Variometers**, winglets, mylar seals - all products designed and built this side of the Atlantic! Peter Masak, High Performance Engineering, (713) 431-1795 (B), 431-2228 (Fax).

**Variometer / Calculator.** Versatile pressure transducer and microprocessor based vario and final glide calculator. Canadian designed and produced. Skytronics, 45 Carmichael Court, Kanata ON K2K 1K1. (613) 820-3751 or 592-0657.

**Firmal Electronics.** Cambridge variometers, L Nav and S Nav now both available with Global Positioning System (GPS) option. You need never be lost again! Write for list or phone John Firth, 542 Coronation Avenue, Ottawa K1G 0M4 (613) 731-6997.

**MZ Supplies.** CONFOR foam, Becker radios, most German soaring instruments. 1450 Goth Ave, Gloucester, ON K1T 1E4 tel/fax (613) 523-2581.

### SAILPLANE DEALERS

**Schempp-Hirth.** Nimbus, Janus, Ventus, Discus. Al Schreiter, 3298 Lonefeather Cres, Mississauga, ON L4Y 3G5 (416) 625-0400 (H), 597-1999 (B).

**Schleicher.** ASK-21, 23, ASW-22, 24, ASH-25. Ulli Werneburg, 1450 Goth Avenue, Gloucester, ON K1T 1E4 (613) 523-2581.

**Schweizer parts.** Walter Chmela, (416) 221-3888 (B), 223-6487 (H), #203, 4750 Yonge Street, Willowdale ON M2N 5M6.

**Solaire Canada.** Ed Hollestelle (519) 455-3316 tel & fax. SZD-55-1, Krosno, PW-5, trailers, GPS, and other sailplane stuff.



## PROVINCIAL ASSOCIATIONS

### NOVA SCOTIA SOARING ASSOCIATION

5546 Sentinel Square  
Halifax, NS B3K 4A9  
(902) 455-4045

President: Gordon Waugh

### FEDERATION DE VOL A VOILE DU QUEBEC

5140 St-Patrick  
Montréal, PQ H4E 4N5  
(514) 362-7363

President: Pierre Pepin

### ONTARIO SOARING ASSN

1112 - 33 Isabella Street  
Toronto, ON M4Y 2P7  
(416) 920-0484

President: Ken Withrow

### MANITOBA SOARING COUNCIL

1328 Wellington Crescent  
Winnipeg, MB R3N 0B1  
(204) 489-6734 (work)

President: Jim Cook

### SOARING ASSOCIATION OF SASKATCHEWAN

78 Schneider Crescent  
Regina, SK S4R 7R5  
(306) 545-6856

President: Gary Bozek

### ALBERTA SOARING COUNCIL

Box 1916  
Claresholm, AB T0L 0T0  
(403) 481-3866

President: Marty Slater

### BC SOARING SOCIETY

Box 91562  
West Vancouver, BC  
V6G 1T2  
(604) 669-9415

President: Dave Parsey

## MARITIME ZONE

BLUENOSE SOARING CLUB  
Ron Van Houten  
17 John Brenton Drive  
Dartmouth, NS B2X 2V5  
(902) 434-1032

## QUEBEC ZONE

AERO CLUB DES OUTARDES  
Luc Boileau  
876 Bergeron  
Ste-Thérèse, PQ J7E 4W8  
(514) 430-0367

ASSOCIATION DE VOL A VOILE CHAMPLAIN  
Claude Gosselin  
30 des Orties  
La Prairie, PQ J5R 5J3  
(514) 444-3450

CLUB DE VOL A VOILE DE QUEBEC  
Jean-Guy Hélie  
85 Route de la Jacques-Cartier  
Ste-Catherine, PQ G0A 3M0  
(418) 875-2005

MONTREAL SOARING COUNCIL  
Box 1082  
St. Laurent, PQ H4L 4W6

CLUB DE VOL A VOILE MONT VALIN  
3434 Ch. Ste Famille  
Chicoutimi, PQ G7H 5B1

## ONTARIO ZONE

AIR SAILING CLUB  
Richard Longhurst  
100, 1446 Don Mills Road  
Don Mills, ON M3B 3N6  
(416) 391-3100 ext 250 (W)

ARTHUR GLIDING CLUB  
10 Courtwood Place  
North York, ON M2K 1Z9

BASE BORDEN SOARING  
c/o OC Rec. Platoon, CFS PER  
CFB Borden, ON L0M 1C0

BEAVER VALLEY SOARING  
Doug Munro  
187 Chatham Avenue  
Toronto, ON M4J 1K8  
(416) 466-1046

BONNECHERE SOARING  
Box 1081  
Deep River, ON K0J 1P0

CENTRAL ONTARIO SOARING ASSOCIATION  
Bob Leger  
866 Hyland Street  
Whitby, ON L1N 6S1  
(416) 668-5111

ERIN SOARING SOCIETY  
Box 36060,  
9025 Torbram Rd  
Bramalea, ON L6S 6A3

GATINEAU GLIDING CLUB  
Rick Officer  
1085 St. Jovite Ridge  
Orleans, ON K1C 1Y6  
(613) 824-1174

GUELPH GLIDING & SOARING ASSOCIATION  
G. Ritchie (519) 763-7150  
259 Cole Road  
Guelph, ON N1G 3K1

LONDON SOARING SOCIETY  
Brian Keron  
RR 2,  
Thamesford, ON N0M 2M0  
(519) 285-2379

RIDEAU GLIDING CLUB  
Box 307  
Kingston, ON K7L 4W2

RIDEAU VALLEY SOARING SCHOOL  
Box 1164  
Manotick, ON K4M 1A9  
(613) 489-2691

SOSA GLIDING CLUB  
Pat O'Donnell  
74 Lincoln Avenue  
Brantford, ON N3T 4S9  
(519) 753-9136

TORONTO SOARING CLUB  
Stephen Foster  
10 Blyth Street  
Richmond Hill, ON L4E 2X7  
(416) 773-4147

WINDSOR GLIDING CLUB  
Box 2172  
Walkerville, ON N8Y 4R8

YORK SOARING ASSN  
10 Courtwood Place  
North York, ON M2K 1Z9

## PRAIRIE ZONE

GRAVELBOURG GLIDING & SOARING CLUB  
Mark Jaibert  
Box 213  
Lafleche, SK S0H 2K0  
(306) 472-5668

PRINCE ALBERT GLIDING & SOARING CLUB  
219 Scissons Court  
Saskatoon, SK S7S 1B7

REGINA GLIDING & SOARING CLUB  
James Thompson  
Box 4093  
Regina, SK S4P 3W5  
(306) 536-4119 or 536-5759

SASKATOON SOARING CLUB  
Box 7943  
Saskatoon, SK S7K 4R6

WINNIPEG GLIDING CLUB  
Susan or Mike Maskell  
489 Lodge Avenue  
Winnipeg, MB R3J 0S5  
(204) 837-8128

SWAN VALLEY SOARING ASSN  
Sam Namaka  
Box 1827  
Swan River, MB R0L 1Z0  
(204) 734-4677

WESTMAN SOARING CLUB  
Box 1294  
Brandon, MB R7A 6N2

## ALBERTA ZONE

COLD LAKE SOARING CLUB  
Randy Blackwell  
Box 2108  
Medley, AB T0A 2M0  
(403) 594-2171

CU NIM GLIDING CLUB  
Keith Hay  
7 Scenic Glen Gate NW  
Calgary, AB T3L 1K5  
(403) 239-5179

EDMONTON SOARING CLUB  
Dave Puckrin  
Box 472  
Edmonton, AB T5J 2K1  
(403) 459-8535

GRANDE PRAIRIE SOARING SOCIETY  
Walter Mueller  
10317 - 82 Avenue  
Grande Prairie, AB T8W 2A6  
(403) 539-6991

## PACIFIC ZONE

ALBERNI VALLEY SOARING ASSN  
Doug Moore,  
Site 310, C6, RR3  
Port Alberni, BC V9Y 7L7  
(604) 723-9385

ASTRA  
9280 - 168 Street  
Surrey, BC V4N 3G3  
(604) 589-4552

BULKLEY VALLEY SOARING  
Ted Schmidt  
Box 474  
Smithers, BC V0J 2N0  
(604) 847-3585

VANCOUVER SOARING ASSN  
Membership Secretary  
Box 3251  
Vancouver, BC V6B 3X9  
(604) 521-5501

## SAC SUPPLIES FOR CERTIFICATES AND BADGES

1	FAI 'A' badge, silver plate pin	\$ 5.00
2	FAI 'B' badge, silver plate pin	\$ 5.00
<i>Items 3-12 ordered through FAI awards chairman</i>		
3	SAC BRONZE badge pin (available from your club)	\$ 6.00
4	FAI 'C' badge, cloth, 3" dia.	\$ 4.50
5	FAI SILVER badge, cloth 3" dia.	\$ 4.50
6	FAI GOLD badge, cloth 3" dia.	\$ 4.50
7	FAI 'C' badge, silver plate pin	\$ 5.00
8	FAI SILVER badge, pin	\$39.00
9	FAI GOLD badge, gold plate pin	\$35.00
<i>Items 10, 11 not stocked - external purchase approval given</i>		
10	FAI GOLD badge 10k or 14k pin	
11	FAI DIAMOND badge, 10k or 14k pin and diamonds	
12	FAI Gliding Certificate (record of badge achievements)	\$10.00
	<b>Processing fee</b> for each FAI application form submitted	<b>\$10.00</b>
13	FAI badge application form (also stocked by club)	n/c
14	Official Observer application form (also stocked by club)	n/c
15	SAC Flight Trophies application form (also stocked by club)	n/c
16	FAI Records application form	n/c
17	SAC Flight Declaration form (also stocked by club) per sheet	\$ 0.15
18	SAC guide "Badge and Records Procedures", ed. 6	\$ 5.00
19	<b>FAI Sporting Code, Section 3, Gliders, 1992</b>	<b>\$ 7.00</b>
	<b>available from and payable to the Aeroclub of Canada (address below)</b>	

Please enclose payment with order; price includes postage. GST not required. Ontario residents, add 8% sales tax. Items 1-6 and 13-18 available from SAC National Office. Check with your club first if you are looking for forms.

**SAC National Office,** 111 - 1090 Ambleside Drive, Ottawa, ON K2B 8G7 tel (613) 829-0536 • fax (613) 829-9497

**Aeroclub of/du Canada,** 9 - 5100 South Service Road, Burlington, ON L7L 6A5 tel (905) 333-1407 • fax (905) 333-2673

## ARTICLES ACVV POUR CERTIFICATS ET INSIGNES

Insigne FAI 'A', plaqué argent	\$ 5.00
Insigne FAI 'B', plaqué argent	\$ 5.00
<i>Les articles 3-12 sont disponibles au président des prix de la FAI</i>	
Insigne ACVV BRONZE (disponible au club)	\$ 6.00
Insigne FAI 'C', écusson de tissu	\$ 4.50
Insigne FAI ARGENT, écusson de tissu	\$ 4.50
Insigne FAI OR, écusson de tissu	\$ 4.50
Insigne FAI 'C', plaqué argent	\$ 5.00
Insigne FAI ARGENT	\$39.00
Insigne FAI OR, plaqué or	\$35.00
<i>Les articles 10, 11 ne sont pas en stock - permis d'achat externe</i>	
Insigne FAI OR, 10k ou 14k	
Insigne FAI DIAMAND, 10k ou 14k et diamands	
Certificat FAI de vol à voile (recueil des insignes)	
<b>Frais de services</b> pour chaque formulaire de demande soumis	
Formulaire de demande pour insignes (disponible au club)	
Formulaire de demande pour observateur officiel (disponible au club)	
Formulaire de demande pour trophées de vol de l'ACVV	
Formulaire de demande pour records FAI	
Formulaire de déclaration de vol de l'ACVV	
ACVV guide des procédures pour FAI certificats et insignes (éd.6)	
<b>FAI Code Sportif, Planeurs, 1992</b>	
<b>disponible et payable à l'Aéroclub du Canada (l'adresse ci-dessous)</b>	

Votre paiement devrait accompagner la commande. La livraison est incluse dans le prix. TPS n'est pas requise. Les résidents de l'Ontario sont priés d'ajouter la taxe de 8%. Les articles 1-6 et 13-18 sont disponibles au bureau national de l'ACVV.